

AUDIO, VIDEO & NAVIGATION



INDIAN & VICTORY

WINDSHIELDS

SEATS & SISSY BARS

LUGGAGE

WHEELS

BRAKES

CHASSIS

SUSPENSION

SHEET METAL

EXHAUST

FUEL & AIR SYSTEMS

ENGINE

PRIMARY DRIVE

TRANSMISSION & FINAL DRIVE

GASKETS

HANDLEBARS & CONTROL

CABLES

FOOT CONTROL

INSTRUMENT & LIGHTING

ELECTRICAL

SECURITY & COVERS

GENERAL ACCESSORIES & DISPLAY

CROSS REFERENCE



### NATIONAL CYCLE® SINGLE HOLDSTER WINDSHIELD BAG

- 553001 Fits: Wide Frame Heavy Duty windshields
- Made in USA



Style	Size	Mfg/N	P/N
Wide Frame Heavy-Duty	12.5" x 5" x 3.5"	N1310A	553001



415477

### HARBAGGER™ LOCK & DOCK LOWER FAIRING DOORS

The Hardbagger™ Lock & Dock Lower Fairing Doors feature replace existing O.E.M. Harley-Davidson® Lower Fairing snap-in Flat Cover Panels. These black cast aluminum locking door sets drop in place and use existing lower snap holes in the O.E.M. panel fairing frame. Once installed, the doors will safely hinge open to full 90° and can also be lifted out and completely removed when at a 45° angle for full fairing pocket access/fluid services.

- Easy to install with no tools or hardware
- Includes a Hardbagger logo medallion
- Designed specifically for the factory pop-out style doors and will not fit if your factory lower fairing doors are already hinged

Note: Cup Holder option accessory, P/N 415479, installs securely in a few minutes without any tools. The Cup/Bottle Holder option offers an oversized, all-weather pocket and sturdy cast aluminum swivel frame for years of use.

HARLEY-DAVIDSON	Year	Pack	P/N
FLHTCU TC	14-22	Single	415477
FLHTCU TC	14-22	Set of 2	415478

# KURYAKYN



### KURYAKYN® FAIRING LOWER DOOR POCKETS

These handy pouches mount directly over the factory lower fairing panels, providing a convenient storage option to keep smaller items at your fingertips. Clean lines with premium formed vinyl construction that retains its shape and is also UV tested. Heavy-duty magnetic closures ensure secure storage and easy opening or closing of the top lid.

- Interior mesh wall keeps items securely in place
- UV-tested formed vinyl construction offers shape retention whether empty or full
- Secure mounting to the panels that reinstall seamlessly in place
- Perfect match to the Batwing Fairing Pouch Bag, P/N 419863, sold separately
- Sold in pairs

HARLEY-DAVIDSON	Year	Mfg/N	P/N
FLH, FLT	14-18	5208	419924
FLHTK	14-22	5208	419924
FLHTKL	14-22	5208	419924
FLHTKSE	14-22	5208	419924
FLTRU	16-22	5208	419924
FLTRK	20-22	5208	419924
FLTRUSE	15-16	5208	419924
FLHTCUTG	14-22	5208	419924
FLHTCUTGSE	14-22	5208	419924
FLHXSE	15-17	5208	419924



### HARBAGGER™ LOCK & DOCK LOWER FAIRING DOOR CUP HOLDER MOUNT

Installs securely in minutes without any tools. The Cup/Bottle Holder option offers an oversized, all-weather pocket and sturdy cast aluminum swivel frame for years of use.

- Fits cups/bottles up to 3-1/2" in diameter
- Mounts to Lock & Dock Lower Fairing Doors, P/N 415477 and 415478

P/N  
415479



**MEMPHIS SHADES® BIG ZIPPER POUCH FOR FLH FAIRING**

Add extra storage to your FLH Fairing. Features three small front pouches and one large zippered pouch.

- Made in USA



HARLEY-DAVIDSON	Year	P/N
FLHT, FLHX, FLHTCUTG, FLHXXX	96-13	ME1495



**HOPNEL™ WINDSHIELD TRI-POUCH**

The Hopnel™ Tri-Pouch incorporates a large 7" x 4" clear cellphone pocket on the generous 8" x 4" x 2" center compartment. Cellphones, MP3 players or other devices load from inside the sleeve keeping rain out and devices dry. The clear UV-stabilized surface allows easy screen reading and will hold up in the toughest environments. The two end storage pouches are 4-1/2" W x 3" H x 1-1/2" D. Made from Hopnel's hand-selected marine grade vinyl, these Tri-Pouches will not wear out and each pouch is held closed by convenient hook-and-loop.

HARLEY-DAVIDSON	Year	P/N
FLH, FLT	96-13	411562

**KURYAKYN®**



**KURYAKYN® TRADITIONAL 3-POUCH FAIRING BAG**

More space than the average fairing bag. Pockets are large enough to accommodate items such as iPods®, cellphones or any other gadgets. Constructed from PVC leather. Pockets are easily accessible with magnetic closures.

- Includes all mounting hardware
- Dimensions: 20"W x 2-3/4"H x 3"D, middle pocket measures 9-1/4"W x 2-3/4"H x 3"D
- Fits H-D® traditional Batwing fairing on H-D® Touring models, Kuryakyn® AirMaster fairing and Sportech fairing

Note: Works well with Kuryakyn® Inner Fairing Accent or H-D® Fairing Dash Pad H-D® #58262-05.

HARLEY-DAVIDSON	Year	Mfg/N	P/N
FLHT	96-13	5212	486982



**KURYAKYN® BATWING FAIRING POUCH BAG**

Keep the small essential items at your fingertips with this structurally formed fairing bag that hugs the contours of the Batwing fairing and windshield. Specifically designed for maximum storage with an integrated channel to allow uninterrupted airflow from the Slipstream vent, with full access to the vent adjustment button.

- Premium thermoformed construction retains its shape
- Heavy-duty magnetic closures ensure secure storage and easy access
- Internal zippered storage in the main compartment for added convenience securing loose items
- Clean lines and a compact design that maximizes storage for cell phones, wallets, sunglasses and more

HARLEY-DAVIDSON	Year	Mfg/N	P/N
FLH, FLT	14-21	5261	419863

- AUDIO, VIDEO & NAVIGATION
- INDIAN & VICTORY
- WINDSHIELDS
- SEATS & SISSY BARS
- LUGGAGE
- WHEELS
- BRAKES
- CHASSIS
- SUSPENSION
- SHEET METAL
- EXHAUST
- FUEL & AIR SYSTEMS
- ENGINE
- PRIMARY DRIVE
- TRANSMISSION & FINAL DRIVE
- GASKETS
- HANDLEBARS & CONTROL
- CABLES
- FOOT CONTROL
- INSTRUMENT & LIGHTING
- ELECTRICAL
- SECURITY & COVERS
- GENERAL ACCESSORIES & DISPLAY
- CROSS REFERENCE

AUDIO,  
VIDEO &  
NAVIGATION

INDIAN  
& VICTORY

WINDSHIELDS

SEATS &  
SISSY BARS

LUGGAGE

WHEELS

BRAKES

CHASSIS

SUSPENSION

SHEET METAL

EXHAUST

FUEL & AIR  
SYSTEMS

ENGINE

PRIMARY  
DRIVE

TRANSMISSION  
& FINAL DRIVE

GASKETS

HANDLEBARS  
& CONTROL

CABLES

FOOT  
CONTROL

INSTRUMENT  
& LIGHTING

ELECTRICAL

SECURITY  
& COVERS

GENERAL  
ACCESSORIES  
& DISPLAY

CROSS  
REFERENCE



### WILLIE & MAX® UNIVERSAL DUAL POUCH WINDSHIELD BAG

Designed to fit a 3-1/2" or taller fairing windshield. Windshield bag is supported by a plastic back with alignment notches designed to fit around the windshield retaining screws.

- Easy to install
- Made in USA



Mfg/N	Dimensions	P/N
04725	21.25" W x 6.5" H x 2.25" D	108893



### WILLIE & MAX® HANDLEBAR/WINDSHIELD POUCH

Constructed of black synthetic leather for uncompromising durability. This convenient pouch mounts to the handlebar, highway bar or grab handles with cable ties and to the windshield with a peel-and-stick, hook-and-loop attachment. Great for making small items easily accessible, for all styles of bikes.

- Made in USA



Mfg/N	Dimensions	P/N
58611-00	7-1/2" W x 4" H x 2-1/2" D	108447



### WILLIE & MAX® TAKE ALONG WINDSHIELD BAG

Custom mounting bracket mounts to windshield crossbar using existing nuts and bolts. Bag mounts directly to bracket with turnbuckle closures

- Accessory carry/shoulder strap included
- Made in USA



Mfg/N	Dimensions	P/N
58011-00	10.5" W x 5.5" H x 3" D	108406



### WILLIE & MAX® REVOLUTION WINDSHIELD BAG

Mounts to the chrome strap on your windshield for handy storage space when you need it most. High-quality chrome quarter turn fastener keeps contents protected. Synthetic leather construction.

- Made in USA



Mfg/N	Dimensions	P/N
59513-00	10.5" W x 6" H x 2.5" D	106366





**MEMPHIS SHADES® TRI-POUCH**

Keep your necessities close at hand with the Memphis Shades® Tri-Pouch.

- Made in USA

Note: Fits Batwing Fairings



**P/N**  
**ME1484**



**MEMPHIS SHADES® WIND DEFLECTORS**

Made of Lucite® for optics and durability. Thermoformed for best function and precise fit. Blackened stainless steel screws and nylon finishing washers included.

- Made in USA
- Sold in pairs



HARLEY-DAVIDSON	Year	Color	P/N
FLH	96-13	Ghost	<b>ME1490</b>



**KURYAKYN®**

**KURYAKYN® AIRMASTER DRAGON WING VARIABLE AIR DEFLECTORS**

An easy replacement for the stock wind deflectors feature a large surface area that helps to direct airflow better than other designs. Close the wing vane to guide airflow around the fairing for reduced turbulence during cool weather or open them for a refreshing breeze on those scorching hot days. Adjust to any of four different positions by hand via spring-loaded mechanism.

- Shatter-resistant polycarbonate construction
- Available in dark smoke or reflective smoke
- Sold in pairs

HARLEY-DAVIDSON	Year	Color	Mfg/N	P/N
FLHT	96-13	Dark Smoke	1108	<b>496902</b>
FLHX	06-13	Dark Smoke	1108	<b>496902</b>
FLHTCUTG, FLHXXX	09-13	Dark Smoke	1108	<b>496902</b>



**KURYAKYN® LED BAT LASHES**

Tried and true style plus increased visibility now offered with integrated sequential turn signals. Auxiliary run-turn functionality featuring white LED running lights and amber LED turn signals that light up individually for consistent direct illumination.

- Requires drilling holes in fairing to route wiring for plug-and-play installation
- Includes run-turn controller
- Sold in pairs

HARLEY-DAVIDSON	Year	Finish	Mfg/N	P/N
FLH, FLT	14-22	Chrome	7131	<b>481319</b>



- AUDIO, VIDEO & NAVIGATION
- INDIAN & VICTORY
- WINDSHIELDS**
- SEATS & SISSY BARS
- LUGGAGE
- WHEELS
- BRAKES
- CHASSIS
- SUSPENSION
- SHEET METAL
- EXHAUST
- FUEL & AIR SYSTEMS
- ENGINE
- PRIMARY DRIVE
- TRANSMISSION & FINAL DRIVE
- GASKETS
- HANDLEBARS & CONTROL
- CABLES
- FOOT CONTROL
- INSTRUMENT & LIGHTING
- ELECTRICAL
- SECURITY & COVERS
- GENERAL ACCESSORIES & DISPLAY
- CROSS REFERENCE

**KURYAKYN** 

AUDIO, VIDEO & NAVIGATION

INDIAN & VICTORY

**WINDSHIELDS**

SEATS & SISSY BARS

LUGGAGE

WHEELS

BRAKES

CHASSIS

SUSPENSION

SHEET METAL

EXHAUST

FUEL & AIR SYSTEMS

ENGINE

PRIMARY DRIVE

TRANSMISSION & FINAL DRIVE

GASKETS

HANDLEBARS & CONTROL

CABLES

FOOT CONTROL

INSTRUMENT & LIGHTING

ELECTRICAL

SECURITY & COVERS

GENERAL ACCESSORIES & DISPLAY

CROSS REFERENCE

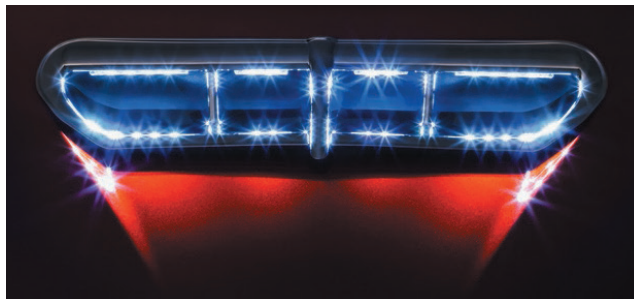

418489

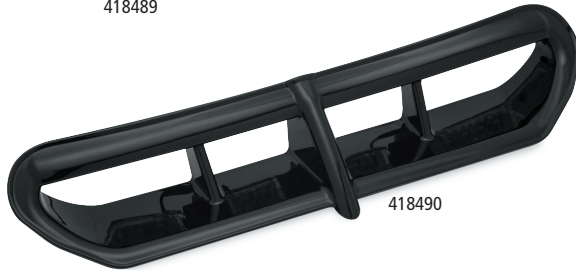

418490

**KURYAKYN® LED FAIRING VENT ACCENT**

A clean and simple solution to update the look of the boring black vent on the new Electra Glide, Street Glide and Trike fairing.

HARLEY-DAVIDSON	Year	Finish	Mfg/N	P/N
FLH, FLHTCUTG	14-22	Chrome	5053	<b>418489</b>
FLH, FLHTCUTG	14-22	Black	5056	<b>418490</b>



419983



419984

**KURYAKYN® TRI-LINE FAIRING INNER ACCENTS**

Sleek and streamlined with a brilliant chrome finish, these accents are sure to add distinctive style to your outer fairing. Designed to complement the traditional Batwing shape with their unique Tri-Line feature.

- Easy peel-and-stick installation

HARLEY-DAVIDSON	Year	Finish	Mfg/N	P/N
FLH, FLHTCUTG, FLHXXX	14-22	Chrome	6978	<b>419983</b>
FLH, FLHTCUTG, FLHXXX	14-22	Black	6979	<b>419984</b>



419916



419917

**KURYAKYN® MESH HEADLIGHT VENT ACCENTS**

The rugged and industrial grilled design delivers an aggressive styling enhancement for the headlight vent. Aluminum outer frame with formed steel mesh panel provides sharp contrasting elements and impactful visual appeal.

- Easy installation that does not require fairing removal, and does not impede fairing removal once installed
- Available in chrome or satin black finish
- Styled to coordinate with the entire Mesh collection for Harley-Davidson models

HARLEY-DAVIDSON	Year	Finish	Mfg/N	P/N
FLTR	15-22	Chrome	6518	<b>419916</b>
FLTR	15-22	Black	6519	<b>419917</b>

**ARLEN NESS**



263896  
10-Gauge



263897  
Deep-Cut

**ARLEN NESS FAIRING INSERTS**

Add style to the factory fairing vent with your choice of Deep Cut or 10-Gauge designs.

- Fairing inserts forged from aluminum then CNC machined to perfection
- Simple installation

HARLEY-DAVIDSON	Year	Style	P/N
FLHX	08-22	10-Gauge	<b>263896</b>
FLHX	08-22	Deep Cut	<b>263897</b>



**PERFORMANCE MACHINE WINDSCREEN TRIM**

CNC laser-cut from 6061-T6 aluminum, this windscreen trim is precision-machined for a perfect fit.



PM3622  
Contrast Cut

*Holeshot*

HARLEY-DAVIDSON	Year	Finish	P/N
FLH	14-22	Contrast Cut	<b>PM3487</b>
FLH	14-22	Black Ops	<b>PM3489</b>
FLTR	15-22	Contrast Cut	<b>PM3622</b>



Contrast Cut



Black Ops

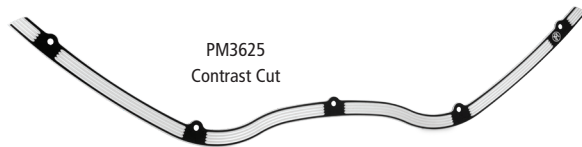

PM3625  
Contrast Cut

*Merc*

HARLEY-DAVIDSON	Year	Finish	P/N
FLH	14-22	Contrast Cut	<b>PM3490</b>
FLH	14-22	Chrome	<b>PM3491</b>
FLH	14-22	Black Ops	<b>PM3492</b>
FLH	98-13	Contrast Cut	<b>PM3499</b>
FLH	98-13	Black Ops	<b>PM3501</b>
FLTR	15-22	Contrast Cut	<b>PM3625</b>



Contrast Cut



Chrome



Black Ops



PM3630  
Black Ops

*Scallop*

HARLEY-DAVIDSON	Year	Finish	P/N
FLH	14-22	Contrast Cut	<b>PM3493</b>
FLH	14-22	Chrome	<b>PM3494</b>
FLH	14-22	Black Ops	<b>PM3495</b>
FLH	98-13	Contrast Cut	<b>PM3502</b>
FLH	98-13	Chrome	<b>PM3503</b>
FLTR	15-22	Contrast Cut	<b>PM3628</b>
FLTR	15-22	Chrome	<b>PM3629</b>
FLTR	15-22	Black Ops	<b>PM3630</b>
FLTR	98-13	Contrast Cut	<b>PM3575</b>
FLTR	98-13	Black Ops	<b>PM3577</b>



Contrast Cut



Chrome



Black Ops

AUDIO,  
VIDEO &  
NAVIGATION

INDIAN  
& VICTORY

WINDSHIELDS

SEATS &  
SISSY BARS

LUGGAGE

WHEELS

BRAKES

CHASSIS

SUSPENSION

SHEET METAL

EXHAUST

FUEL & AIR  
SYSTEMS

ENGINE

PRIMARY  
DRIVE

TRANSMISSION  
& FINAL DRIVE

GASKETS

HANDLEBARS  
& CONTROL

CABLES

FOOT  
CONTROL

INSTRUMENT  
& LIGHTING

ELECTRICAL

SECURITY  
& COVERS

GENERAL  
ACCESSORIES  
& DISPLAY

CROSS  
REFERENCE

AUDIO, VIDEO & NAVIGATION

**KURYAKYN** 

INDIAN & VICTORY

WINDSHIELDS

SEATS & SISSY BARS

LUGGAGE

WHEELS

BRAKES

CHASSIS

SUSPENSION

SHEET METAL

EXHAUST

FUEL & AIR SYSTEMS

ENGINE

PRIMARY DRIVE

TRANSMISSION & FINAL DRIVE

GASKETS

HANDLEBARS & CONTROL

CABLES

FOOT CONTROL

INSTRUMENT & LIGHTING

ELECTRICAL

SECURITY & COVERS

GENERAL ACCESSORIES & DISPLAY

CROSS REFERENCE

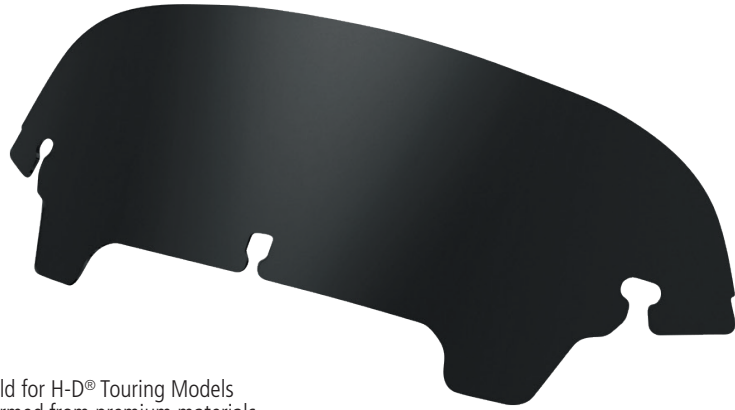

**KURYAKYN® AIRMASTER WINDSHIELDS**

Kuryakyn is fired up to offer this top-quality, custom windshield for H-D® Touring Models and AirMaster Fairings. This high-end windshield is custom-formed from premium materials using a proprietary process. Crown your bagger with the coolest windshield available.

- Manufactured from premium quality, hard-coated polycarbonate
- Unlike acrylic, polycarbonate will not crack or shatter upon impact
- Graphics are screen printed with proprietary inks making the images unbelievably sharp and durable at the same time
- Windshields are opaque, take into account that you must maintain a clear line of sight over the windshield
- The windshield should not obstruct your vision in any way

Note: Windshields are opaque, take into account that you must maintain a clear line of sight over the windshield. The windshield should not obstruct your vision in any way.

HARLEY-DAVIDSON	Year	5"	Style	Mfg/N	7"	Style	Mfg/N
FLHT, FLHX, FLHTCUTG	14-22	<b>419773</b>	Dark Smoke	1770	<b>419774</b>	Dark Smoke	1771
FLHT, FLHX, FLHTCUTG	96-13	<b>419776</b>	Dark Smoke	1773	<b>419777</b>	Dark Smoke	1774



**KURYAKYN® SIDE AND CENTER WINDSHIELD TRIM FOR ROAD GLIDE**

Enhance the transition from windshield to fairing on the 15-21 Road Glide® with our chrome or gloss black side and center windshield trims that provide a clean, smooth-flowing appearance. Choose the side trims only, or complete the look with the center trim for full coverage. Made from lightweight injection-molded ABS, installation of the gloss black trim pieces reuses O.E.M. hardware while the chrome versions come with stainless steel replacement screws.

HARLEY-DAVIDSON	Year	Position	Finish	Mfg/N	P/N
FLTR	15-22	Side	Chrome	2632	<b>419966</b>
FLTR	15-22	Side	Black	2633	<b>419967</b>
FLTR	15-22	Center	Chrome	2634	<b>419968</b>
FLTR	15-22	Center	Black	2635	<b>419969</b>

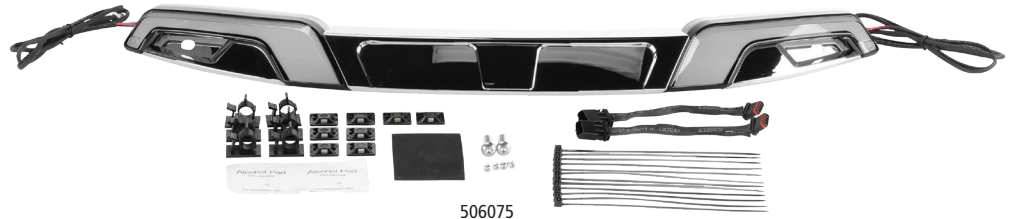

506075

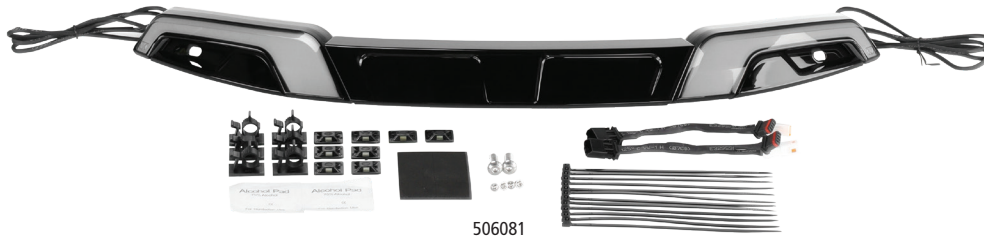

506081

**NEW!**

**KURYAKYN® TRACER WINDSHIELD TRIM FOR V-TWIN**

The Tracer Windshield Trim Lights feature a fully diffused LED lighting system. Significantly enhance your bike with style and visibility.

HARLEY-DAVIDSON	Year	Finish	P/N
FLHT, FLHX	14-22	Chrome	<b>506075</b>
FLHT, FLHX	14-22	Gloss Black	<b>506081</b>

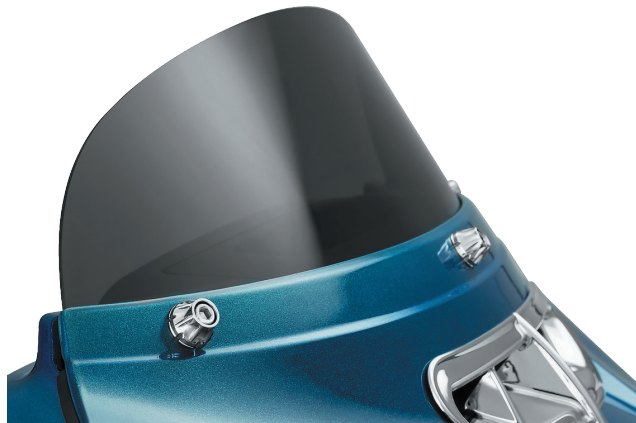

Chrome



Black



Chrome

**KURYAKYN® DECORATIVE WINDSHIELD SCREWS**

Change the look and attitude of your fairing with these direct replacements for the stock bolts featuring durable cast-aluminum accents and steel fasteners.

HARLEY-DAVIDSON	Year	Mfg/N	Finish	P/N
FLHT, FLHX	14-22	5719	Chrome	<b>485034</b>
FLHT, FLHX	14-22	5720	Black	<b>485035</b>
FLHT, FLHX	96-13	5717	Chrome	<b>485032</b>
FLHT, FLHX	96-13	5718	Black	<b>485033</b>
FLTR	15-22	5722	Black	<b>485059</b>

**KURYAKYN® WINDSHIELD MOUNTING SPIKES**

Also fits Kuryakyn AirMaster® Fairing.

- 1/4-20 x 5/8"
- Sold in a set of three

HARLEY-DAVIDSON	Year	Finish	Mfg/N	P/N
FLHT, FLHX	14-22	Chrome	5713	<b>411729</b>
FLHT, FLHX	14-22	Black	5714	<b>411730</b>
FLHT, FLHX	96-13	Chrome	1369	<b>419032</b>
FLHT, FLHX	96-13	Black	5712	<b>411728</b>
FLTR	15-22	Chrome	5715	<b>411731</b>
FLTR	15-22	Black	5716	<b>411732</b>
FLHTCUTG, FLHXXX	09-13	Chrome	1369	<b>419032</b>

- AUDIO, VIDEO & NAVIGATION
- INDIAN & VICTORY
- WINDSHIELDS**
- SEATS & SISSY BARS
- LUGGAGE
- WHEELS
- BRAKES
- CHASSIS
- SUSPENSION
- SHEET METAL
- EXHAUST
- FUEL & AIR SYSTEMS
- ENGINE
- PRIMARY DRIVE
- TRANSMISSION & FINAL DRIVE
- GASKETS
- HANDLEBARS & CONTROL
- CABLES
- FOOT CONTROL
- INSTRUMENT & LIGHTING
- ELECTRICAL
- SECURITY & COVERS
- GENERAL ACCESSORIES & DISPLAY
- CROSS REFERENCE



## ARLEN NESS

- AUDIO, VIDEO & NAVIGATION
- INDIAN & VICTORY
- WINDSHIELDS**
- SEATS & SISSY BARS
- LUGGAGE
- WHEELS
- BRAKES
- CHASSIS
- SUSPENSION
- SHEET METAL
- EXHAUST
- FUEL & AIR SYSTEMS
- ENGINE
- PRIMARY DRIVE
- TRANSMISSION & FINAL DRIVE
- GASKETS
- HANDLEBARS & CONTROL
- CABLES
- FOOT CONTROL
- INSTRUMENT & LIGHTING
- ELECTRICAL
- SECURITY & COVERS
- GENERAL ACCESSORIES & DISPLAY
- CROSS REFERENCE



### ARLEN NESS DIRECT BOLT-ON FAIRING KIT

Constructed of heavy ABS plastic while the windshield is made from smoked plexiglass.

- Fairing bodies are available in gloss black finish or paintable finish

HARLEY-DAVIDSON	Year	Finish	P/N
FXD	06-17	Gloss Black	<b>262887<sup>1</sup></b>
FXD	06-17	Paintable	<b>262888<sup>3</sup></b>

<sup>1</sup> Exc. FXDF and FXDGW models

### Direct Bolt-On Fairing Kit Replacement Windshield

Description	P/N
Smoked Windshield	<b>262891</b>



### ARLEN NESS FAIRING KITS

The universal design can be used on various applications. Choose from louvered, plain or wide-glide/custom mid-glide.

- Constructed of heavy ABS plastic while the windshield is made from smoked plexiglass
- Universal mounting brackets included in kit, may need to be modified according to application

Includes:

- Fairing body
- Smoked windshield
- Universal mounting brackets
- Windshield mounting fasteners

#### Narrow Glide Fairing Kits

Application	Style	P/N
Narrow Glide with 39mm	Plain	<b>260832</b>
Narrow Glide with 39mm	Louvered	<b>260833</b>

#### Wide Glide Fairing Kits

Application	P/N
Fits Most Models with Wide Glide Front Ends	<b>260834<sup>1</sup></b>

<sup>1</sup> Does not include mounting brackets





772627



772629



772628



772626

**BURLY BRAND FAIRINGS**

Introducing the Burly Brand line of fairings: Unique universal designs for most applications with a 5-3/4" headlight. Fairings are made of high quality molded ABS and paired with impact resistant Acrylic windscreens for strength and durability. Included with all fairings is a universal mounting kit that provides you with everything you need to install on your motorcycle. Mounting brackets are made of black powder-coated heavy duty steel and allow for a great range of adjustability, allowing you to get your fairing set up just how you like it while remaining as low profile as possible. Available for 35mm-49mm forks.

Touring Sport Fairing:

The Touring Sport fairing embodies an aggressive cruiser style (inspired by FXR and T-Sport DNA). The sweeping lines flow nicely with the motorcycle and look great with a variety of handlebar setups. Flanking the headlight bucket are two styling pockets with great potential for further customization with lighting. Available with both tall and short windscreen options that securely mount with corrosion resistant black hardware. Take your next expedition with the Touring Sport Fairing.

Café Sport Fairing:

Minimal and sporty, the Café Sport fairing adds just the right amount of style in a compact package. The simple one-piece fairing evokes a sense of speed with its scooped styling pockets and tight tucked mounting position. Add some extra character and clean up the front end of your bike with the Café Sport fairing.

Outlaw Fairing:

The Outlaw fairing is clean and mean. With a refined style inspired by classic motorcycle heritage, this fairing brings a road warrior attitude to any bike. The impact resistant Acrylic windscreen fits flush with the fairing, mounting with corrosion resistant black hardware.

- Corrosion resistant black hardware

HARLEY-DAVIDSON	Year	Style	P/N
FXST, FXD, FXR, XL	57-22	Touring Sport Standard	<b>772628</b>
FXST, FXD, FXR, XL	57-22	Touring Sport Tall	<b>772629</b>
FXST, FXD, FXR, XL	57-22	Café Sport	<b>772627</b>
FXST, FXD, FXR, XL	57-22	Outlaw	<b>772626</b>

AUDIO, VIDEO & NAVIGATION

INDIAN & VICTORY

WINDSHIELDS

SEATS & SISSY BARS

LUGGAGE

WHEELS

BRAKES

CHASSIS

SUSPENSION

SHEET METAL

EXHAUST

FUEL & AIR SYSTEMS

ENGINE

PRIMARY DRIVE

TRANSMISSION & FINAL DRIVE

GASKETS

HANDLEBARS & CONTROL

CABLES

FOOT CONTROL

INSTRUMENT & LIGHTING

ELECTRICAL

SECURITY & COVERS

GENERAL ACCESSORIES & DISPLAY

CROSS REFERENCE

AUDIO,  
VIDEO &  
NAVIGATION



INDIAN  
& VICTORY

WINDSHIELDS

### MEMPHIS SHADES® SPOILER WINDSHIELDS FOR BATWING FAIRINGS

Designed to be looked over, the Memphis Shades® Spoiler Windshields for Batwing Fairings diffuse the air stream, effectively slowing the flow without buffeting.

- Fits all Memphis Shades Batwing Fairings
- Made of durable Lucite® for the best quality
- Available in 5", 6.5" and 9"
- Available in Smoke (medium bronze tint with 30% visible light transmission) or Dark Black Smoke (black tint with 25% visible light transmission)
- Made in USA



Height	Color	P/N
5"	Dark Black Smoke	<b>ME0115</b>
6.5"	Dark Black Smoke	<b>ME0116</b>
6.5"	Smoke	<b>ME0118</b>
5"	Smoke	<b>ME0121</b>
9"	Smoke	<b>ME0124</b>



ME0124  
Smoke



Dark Black Smoke  
ME0116

SUSPENSION

SHEET METAL

EXHAUST

FUEL & AIR  
SYSTEMS

ENGINE

PRIMARY  
DRIVE

TRANSMISSION  
& FINAL DRIVE

GASKETS

HANDLEBARS  
& CONTROL

CABLES

FOOT  
CONTROL

INSTRUMENT  
& LIGHTING



Solid Black  
ME0133



Clear  
ME0146



Solar  
ME0159

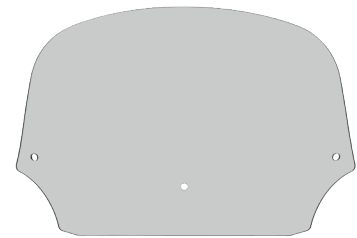

Solar  
ME0152

### MEMPHIS SHADES® WINDSHIELDS FOR BATWING FAIRINGS

The Memphis Shades® Windshields for Batwing Fairings provide superior optics with a durable Lucite® construction.

- Available in Clear, Black and Solar (light tint with 72% visible light transmission)
- 5" windshields are solid translucent while 7", 9" and 12" windshields are gradient translucent
- Optional windshield pouches, fairing trims and wind deflectors sold separately
- Made in USA



Height	Color	P/N	Height	Color	P/N
5"	Clear	<b>ME0132</b>	9"	Clear	<b>ME0146</b>
5"	Solid Black	<b>ME0133</b>	9"	Solar	<b>ME0152</b>
5"	Solar	<b>ME0138</b>	12"	Clear	<b>ME0153</b>
7"	Clear	<b>ME0139</b>	12"	Solar	<b>ME0159</b>
7"	Solar	<b>ME0145</b>			



**MEMPHIS SHADES® BATWING FAIRING STORAGE BAG**

If you like to remove your fairing when trailering, washing your bike or just taking a joy ride, a fairing storage bag can protect your investment. It safely stows in a car trunk, in a motel room, or at home, you can save space and hang it on the garage wall out of harm's way. Why not have fairings for all occasions on your wall? Constructed of 600-denier tool bag material and lined with faux Sherpa to ensure a mar-free surface.

- Safe way to carry or store Memphis Shades Batwing fairing
- Convenient handle for carrying or hanging out of harm's way
- Will hold one Memphis Shades Batwing Fairing with mounting plates and windshield installed
- Made in USA



**P/N**  
**ME1482**



ME0006



ME0007



ME0008

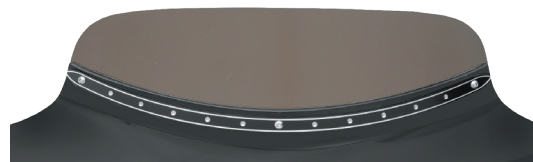

ME0293



ME0294

**MEMPHIS SHADES® BATWING FAIRING TRIM**

Polished stainless steel trim for Memphis Shades Batwing Fairings.

- Made in USA



Style	Finish	P/N
Slotted Fat	Black	<b>ME0006</b>
Night Shades Dots	Black	<b>ME0293</b>
Night Shades Ellipse	Black	<b>ME0294</b>
Slotted Slim	Polished	<b>ME0009</b>
Solid Fat	Polished	<b>ME0007</b>
Solid Slim	Polished	<b>ME0008</b>

- AUDIO, VIDEO & NAVIGATION
- INDIAN & VICTORY
- WINDSHIELDS**
- SEATS & SISSY BARS
- LUGGAGE
- WHEELS
- BRAKES
- CHASSIS
- SUSPENSION
- SHEET METAL
- EXHAUST
- FUEL & AIR SYSTEMS
- ENGINE
- PRIMARY DRIVE
- TRANSMISSION & FINAL DRIVE
- GASKETS
- HANDLEBARS & CONTROL
- CABLES
- FOOT CONTROL
- INSTRUMENT & LIGHTING
- ELECTRICAL
- SECURITY & COVERS
- GENERAL ACCESSORIES & DISPLAY
- CROSS REFERENCE

AUDIO,  
VIDEO &  
NAVIGATION

INDIAN  
& VICTORY

WINDSHIELDS

SEATS &  
SISSY BARS

LUGGAGE

WHEELS

BRAKES

CHASSIS

SUSPENSION

SHEET METAL

EXHAUST

FUEL & AIR  
SYSTEMS

ENGINE

PRIMARY  
DRIVE

TRANSMISSION  
& FINAL DRIVE

GASKETS

HANDLEBARS  
& CONTROL

CABLES

FOOT  
CONTROL

INSTRUMENT  
& LIGHTING

ELECTRICAL

SECURITY  
& COVERS

GENERAL  
ACCESSORIES  
& DISPLAY

CROSS  
REFERENCE



### MEMPHIS SHADES® GAUNTLET FAIRING

The Gauntlet Fairing offers minimalist style and maximum function for your Harley-Davidson® Dyna or Sportster®. A quarter fairing that provides the style you want and torso protection you need for extended mile rides. Comes in a Class A, gloss black finish that looks great as is but can also be easily painted to match your style.

- Unitized quarter fairing with a matte black finish inside
- Smoked windscreen
- Made in USA
- Model-specific Trigger-Lock Mount Kit, sold separately



HARLEY-DAVIDSON	Year	P/N
FXDL	14-17	ME0643
XL1200C	11-19	ME0643
XG	15-20	ME0643



### MEMPHIS SHADES® CAFE FAIRINGS

The Cafe Fairing is the perfect fit when only the most compact and sleek fairing fits the style of your Harley-Davidson®. Designed to fit most of the Sportster and Dyna models, the Cafe Fairing blends old-school style with new-style function. The Cafe Fairing comes in a gloss black Class A finish, so you can leave it stock or easily prep it for paint to match your very own style.

- One piece construction with machined groove outlines
- Class A gloss black finish that looks great as is or can be easily painted
- Made of aircraft-grade Lucite
- Custom-fit, model-specific mounting kits feature Memphis Shades exclusive Trigger Lock Mounting System for on and off without tools
- Made in USA



HARLEY-DAVIDSON	Year	P/N
FXD, FXDC, FXDB	06-17	ME0220
FXDL	14-17	ME0220
FXDL	06-09	ME0220
XL1200T	15-19	ME0220
XL1200X	10-15	ME0220
XL1200N	07-12	ME0220
XL1200L	06-11	ME0220
XL883L	11-19	ME0220
XL883N	09-22	ME0220
XG	15-20	ME0220



ME1187



ME1193

**MEMPHIS SHADES® ROAD WARRIOR WINDSHIELDS**

The Memphis Shades® Road Warrior Windshields are made from durable Lucite® and feature superior optics. Multiple tint and height combinations allow you to find the right look and feel for your ride.

- Dark Black Smoke (black tint with 25% visible light transmission) and Smoke (black tint with 40% visible light transmission)
- Made in USA
- Fits Memphis Shades Road Warrior Fairings

Note: The fairing adds roughly 3" of height to the windshield. An 11" windshield has a 14" height from the top to the headlight opening.



*Road Warrior Windshields*

Size	Color	P/N
7"	Dark Black Smoke	<b>ME1187</b>
11"	Dark Black Smoke	<b>ME1190</b>
11"	Black Smoke	<b>ME1191</b>
13"	Black Smoke	<b>ME1193</b>
15"	Black Smoke	<b>ME1195</b>



ME1201

*Road Warrior Vented Windshields*

Size	Color	P/N
11"	Dark Black Smoke	<b>ME1201</b>



ME1161



ME1163

**MEMPHIS SHADES® TURN SIGNAL RELOCATION KIT**

Allows you to custom-mount Memphis Shades Windshields, or simply to improve the look of your bike.

- Made in USA



Application	Finish	P/N
XG500/750	Black	<b>ME1161</b>
FLST w/o Light Bar	Polished	<b>ME1164</b>
FLST w/o Light Bar	Black	<b>ME1157</b>
FLST w/Light Bar	Polished	<b>ME1163</b>

- AUDIO, VIDEO & NAVIGATION
- INDIAN & VICTORY
- WINDSHIELDS
- SEATS & SISSY BARS
- LUGGAGE
- WHEELS
- BRAKES
- CHASSIS
- SUSPENSION
- SHEET METAL
- EXHAUST
- FUEL & AIR SYSTEMS
- ENGINE
- PRIMARY DRIVE
- TRANSMISSION & FINAL DRIVE
- GASKETS
- HANDLEBARS & CONTROL
- CABLES
- FOOT CONTROL
- INSTRUMENT & LIGHTING
- ELECTRICAL
- SECURITY & COVERS
- GENERAL ACCESSORIES & DISPLAY
- CROSS REFERENCE

AUDIO, VIDEO & NAVIGATION

INDIAN & VICTORY

WINDSHIELDS

SEATS & SISSY BARS

LUGGAGE

WHEELS

BRAKES

CHASSIS

SUSPENSION

SHEET METAL

EXHAUST

FUEL & AIR SYSTEMS

ENGINE

PRIMARY DRIVE

TRANSMISSION & FINAL DRIVE

GASKETS

HANDLEBARS & CONTROL

CABLES

FOOT CONTROL

INSTRUMENT & LIGHTING

ELECTRICAL

SECURITY & COVERS

GENERAL ACCESSORIES & DISPLAY

CROSS REFERENCE



ME1158



ME1532



ME1531

## MEMPHIS SHADES® HEADLIGHT EXTENSION BLOCK

Moves headlight forward in fairing bezels of Gauntlet and Café fairings. (six positions: 1.3" to 2.6") Machined from billet aluminum, e-coated black. Bezels may need to be trimmed for headlight bracket clearance.

- Top mount moves the headlight bucket and lamp forward 3-3/4"
- Instructions included
- Made in USA



Application	Type	Style	Finish	Extension	P/N
FXDWG, XL883C/1200C	Headlight Extension Block	Wide	Black	1.3 to 2.6"	<b>ME1160</b>
FXD	Headlight Extension Block	Standard	Black	1.3 to 2.6"	<b>ME1158</b>
FXLR	Headlight Extension Block	Short	Black	1.5 to 2"	<b>ME1531</b>
FXBB	Headlight Extension Block	Long	Black	1.9 to 3"	<b>ME1532</b>



Solar w/Polished Straps  
ME0323



Clear w/Black Straps  
ME1640

## MEMPHIS SHADES® MEMPHIS FATS WINDSHIELDS

The Memphis Fats feature classic American styling and are available in 50-state D.O.T.-approved Clear, Solar (a light tint with 72% visible light transmission), Black Smoke (black tint with 40% visible light transmission) and Dark Black Smoke (black tint with 25% visible light transmission). At 2" wide and available in five different heights from 13 to 21", if you are looking for a full coverage windshield, the Memphis Fats is the right choice for you.

- Features traditional American styling with a unique cutout for dual headlights
- Five standard heights to choose from; 13", 15", 17", 19", 21"
- Windshield straps are polished stainless steel or black with billet aluminum fittings and stainless steel socket-head screws
- No-tool, detachable Trigger-Lock Mount Kit, sold separately
- Made from Lucite® for excellent optics and durability
- Made in USA



Height	Cutout	Color	P/N
13"	7"	Solar w/Polished Straps	<b>ME0323</b>
17"	7"	Solar w/Polished Straps	<b>ME0337</b>
19"	7"	Clear w/Polished Straps	<b>ME0338</b>
13"	7"	Clear w/Black Straps	<b>ME1640</b>
15"	7"	Clear w/Black Straps	<b>ME1643</b>
17"	7"	Clear w/Black Straps	<b>ME1646</b>
19"	7"	Clear w/Black Straps	<b>ME1648</b>
13"	9"	Clear w/Black Straps	<b>ME1652</b>
15"	9"	Clear w/Black Straps	<b>ME1655</b>
17"	9"	Clear w/Black Straps	<b>ME1658</b>
21"	9"	Clear w/Black Straps	<b>ME1662</b>
21"	9"	Black Smoke w/Black Straps	<b>ME1663</b>

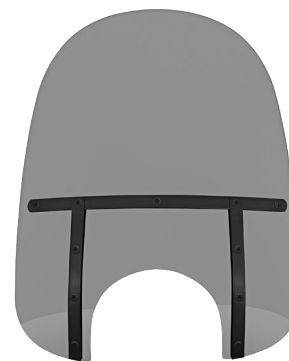

Black Smoke  
w/Black Straps  
ME1663



Clear w/Black Straps  
ME1664



Black Smoke  
w/Polished Straps  
ME1666

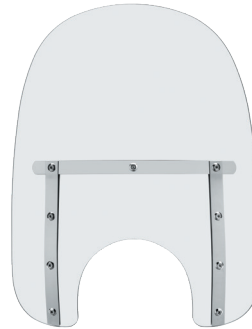

Clear w/Polished Straps  
ME1227

**MEMPHIS SHADES® MEMPHIS SLIMS WINDSHIELDS**

Memphis Slims have all the same styling of the ever-popular Memphis Fats, only slimmed down. Constructed and designed with the same quality as its big brother, with a tighter look and less wind resistance.

- Measures 18" wide
- Two standard heights to choose from: 15" and 17"
- Optional lowers available for additional windshield coverage
- No-tool, detachable Trigger-Lock Mount Kit, sold separately
- Made in USA



Height	Cutout	Color	P/N
15"	7"	Clear w/Black Straps	<b>ME1664</b>
15"	7"	Black Smoke w/Black Straps	<b>ME1666</b>
17"	7"	Clear w/Polished Straps	<b>ME1227</b>
17"	7"	Clear w/Black Straps	<b>ME1670</b>
17"	7"	Black Smoke w/Black Straps	<b>ME1671</b>
15"	9"	Clear w/Black Straps	<b>ME1667</b>
15"	9"	Solar w/Polished Straps	<b>ME1226</b>
17"	9"	Clear w/Black Straps	<b>ME1672</b>

**MEMPHIS SHADES® MEMPHIS FATS WINDSHIELDS FOR ROAD KINGS**

The Memphis Fats feature classic American styling including 50-State D.O.T.-approved Solar and Clear tints. At 2" wide and available in five different heights from 13" to 21", if you are looking for a full coverage windshield, the Memphis Fats is the right one for you!

The windshield is constructed from Lucite® acrylic for excellent optics and durability. Unlike many other brands, these windshields can be repaired with plastic polish (Novus is recommended). The windshield straps are polished stainless steel with CNC-machined billet aluminum fittings and stainless steel socket-head screws, so nothing will ever rust or corrode.

- Features traditional American styling with a unique cutout for dual headlight
- Five standard heights to choose from: 13", 15", 17", 19", 21"
- Windshield straps are polished stainless steel with billet aluminum fittings and stainless steel socket-head screws
- No-Tool, detachable Trigger-Lock Mount Kit, sold separately
- Made from Lucite® for excellent optics and durability
- Made in USA



Height	Cutout	Color	P/N
15"	9"	Solar w/Polished Straps	<b>ME0365</b>
19"	9"	Clear w/Polished Straps	<b>ME0373</b>
19"	9"	Solar w/Polished Straps	<b>ME0379</b>



Solar  
ME0365



Clear  
ME0373

- AUDIO, VIDEO & NAVIGATION
- INDIAN & VICTORY
- WINDSHIELDS**
- SEATS & SISSY BARS
- LUGGAGE
- WHEELS
- BRAKES
- CHASSIS
- SUSPENSION
- SHEET METAL
- EXHAUST
- FUEL & AIR SYSTEMS
- ENGINE
- PRIMARY DRIVE
- TRANSMISSION & FINAL DRIVE
- GASKETS
- HANDLEBARS & CONTROL
- CABLES
- FOOT CONTROL
- INSTRUMENT & LIGHTING
- ELECTRICAL
- SECURITY & COVERS
- GENERAL ACCESSORIES & DISPLAY
- CROSS REFERENCE



AUDIO,  
VIDEO &  
NAVIGATION

INDIAN  
& VICTORY

WINDSHIELDS

SEATS &  
SISSY BARS

LUGGAGE

WHEELS

BRAKES

CHASSIS

SUSPENSION

SHEET METAL

EXHAUST

FUEL & AIR  
SYSTEMS

ENGINE

PRIMARY  
DRIVE

TRANSMISSION  
& FINAL DRIVE

GASKETS

HANDLEBARS  
& CONTROL

CABLES

FOOT  
CONTROL

INSTRUMENT  
& LIGHTING

ELECTRICAL

SECURITY  
& COVERS

GENERAL  
ACCESSORIES  
& DISPLAY

CROSS  
REFERENCE

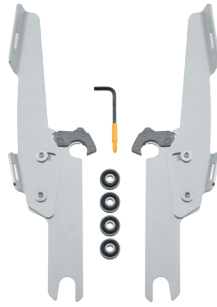

Polished  
ME0030

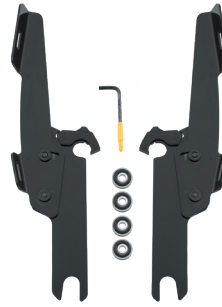

Black  
ME0031



Polished  
ME0492



Black  
ME0461

## MEMPHIS SHADES® MEMPHIS FATS AND SLIM TRIGGER-LOCK MOUNT KITS

Polished Aluminum and Night Shades (Black) painted Trigger-Lock Mount kits (no-tool removal).

- Compatible with Drop-Top Memphis Fats Windshields
- Made in USA



		Mount Kit Polished	Mount Kit Black
<b>TOURING</b>	Year		
	FLHR/C	94-22	<b>ME0030<sup>4</sup></b>
	FLHRXS	17-22	<b>ME1582<sup>4</sup></b>
<b>SHEET METAL</b>	FLHRS	04-07	<b>ME1582<sup>4</sup></b>
	FLRT	15-22	<b>ME0462</b>
<b>EXHAUST</b>	<b>SOFTAIL</b>		
	FXBB, FXST	18-22	<b>ME0475</b>
	FXLR	18-20	<b>ME0492</b>
	FXLRS	20-22	<b>ME1587<sup>5</sup></b>
	FLFB/S	18-22	<b>ME1496<sup>6</sup></b>
	FLSB	18-22	<b>ME1587</b>
<b>ENGINE</b>	FXSB	13-17	<b>ME0476</b>
	FXCW, FXCWC	08-11	<b>ME0475</b>
<b>PRIMARY DRIVE</b>	FXST, FXSTD, FXSTB	85-10	<b>ME0505</b>
	FLSTN	93-96, 05-17	<b>ME0484<sup>1</sup></b>
	FLSTN	93-96, 05-17	<b>ME0507<sup>2</sup></b>
	FLSTF, FLSTFB, FLS	90-17	<b>ME0484<sup>1</sup></b>
<b>TRANSMISSION &amp; FINAL DRIVE</b>	FLSTF, FLSTFB, FLS	90-17	<b>ME0507<sup>2</sup></b>
	FLSTC	86-17	<b>ME0507<sup>2</sup></b>
<b>GASKETS</b>	<b>DYNA</b>		
	FXDLS	16-17	<b>ME0475</b>
	FXDL	14-17	<b>ME0492</b>
<b>HANDLEBARS &amp; CONTROL</b>	FXDL	06-09	<b>ME0475</b>
	FXD, FXDC, FXDB	06-17	<b>ME0475</b>
	FXD, FXDL	91-05	<b>ME0504</b>
<b>CABLES</b>	FXDF	08-17	<b>ME0476</b>
	FXDWG	06-17	<b>ME0476</b>
<b>FOOT CONTROL</b>	FXDWG	93-05	<b>ME0505</b>
	<b>FXR</b>		
<b>INSTRUMENT &amp; LIGHTING</b>	FXR	82-94, 99-00	<b>ME0505</b>
	<b>FX</b>		
<b>ELECTRICAL</b>	FXWG	80-86	<b>ME0505</b>
	FX	73-85	<b>ME0504</b>
	<b>SPORTSTER</b>		
<b>SECURITY &amp; COVERS</b>	XL1200V	13-16	<b>ME0504</b>
	XL1200C	96-10	<b>ME0504</b>
	XL1200N	07-12	<b>ME0504</b>
	XL1200L	06-11	<b>ME0504</b>
<b>GENERAL ACCESSORIES &amp; DISPLAY</b>	XL883L	05-10	<b>ME0504</b>
	XL883N	09-22	<b>ME0504</b>
<b>CROSS REFERENCE</b>	XL883C	96-10	<b>ME0504</b>
	<b>STREET</b>		
	XG	15-20	<b>ME0504<sup>3</sup></b>

<sup>1</sup> Without light bar

<sup>2</sup> With light bar

<sup>3</sup> Requires turn signal relocation kit P/N ME1161

<sup>4</sup> Requires 9" headlight cutout

<sup>5</sup> Requires Headlight Extension Kit P/N ME1713 and Headlight Trim Ring/Shroud Kit Mfgn/N MEB7231

<sup>6</sup> 2018 FLFB/S must use Memphis Fats

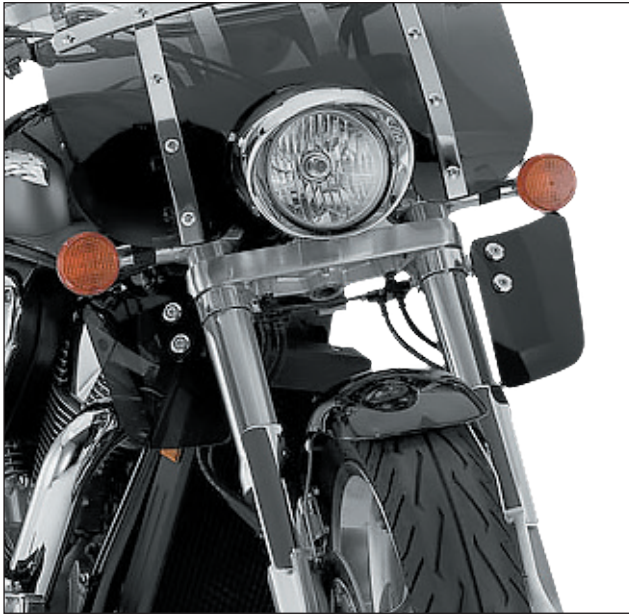

ME1138

**MEMPHIS SHADES® LOWERS**

The Memphis Shades® Lowers provide additional protection by extending your coverage downward while shielding you from wind, rain and noise coming up from road.

- May require turn signal relocation
- Quick-Change mount kits let you install and remove your Lowers in seconds (sold separately)
- Made of the same high-quality materials as Memphis Fats with matching tints that will highlight your windshield
- Made in USA



Color	P/N
Black	ME1138
Solar	ME1143



**MEMPHIS SHADES® LOWERS MOUNT KITS**

- Mount Kits for Memphis Shades® Lowers

HARLEY-DAVIDSON	Year	P/N
FXCW, FXCWC	08-11	ME1156
FLSTSC, FXSTS	88-07	ME1152
FXDL	14-17	ME1156
FXD, FXDC, FXDB	06-17	ME1156
FXDWG	06-17	ME1156
FXWG	80-86	ME1147
VRSCA, VRSCB	02-11	ME1156



**MEMPHIS SHADES® RIO GRANDE SPORTSHIELDS**  
The most coverage in the Sportshield Family.

Large and in charge, the Rio Grande Sportshield is the choice for sporty looks and maximum protection. With its 19" height above the headlight and 21" width, don't let the sleek and slender profile fool you, the Rio Grande is installed to provide you with the protection needed.

- Fits all round headlights
- Measures 21" W x 19" H above headlight
- Made of Lucite® for excellent clarity and weather resistance
- All hardware is CNC-machined billet aluminum and polished stainless steel
- No-Tool, detachable Trigger-Lock mounting kit, sold separately
- Made in USA



Color	P/N
Black Smoke	ME1694
Solar	ME1304



ME1306

**MEMPHIS SHADES® SPEED DEMON SPORTSHIELDS**

Speed; that's what its all about. The Speed Demon Sportshield gives you the fast looks and great protection that you want. With its small winged design, riders notice increased wind protection on their hands. Fast style, great looks and great fit, the Speed Demon delivers it all.

- Offers more protection with a sporty look
- Features a similar shape and style of the popular handlebar mount Demon shield, but with the benefits of easier installation and faster removal due to the exclusive Sportshield mounting kit
- Measures 21" W x 18" H above the headlight
- Made of Lucite® for excellent optics and durability
- No-Tool, detachable Trigger-Lock mounting kit, sold separately
- Made in USA



Cutout	Color	P/N
7"	Black Smoke	ME1696
7"	Solar	ME1306

- AUDIO, VIDEO & NAVIGATION
- INDIAN & VICTORY
- WINDSHIELDS
- SEATS & SISSY BARS
- LUGGAGE
- WHEELS
- BRAKES
- CHASSIS
- SUSPENSION
- SHEET METAL
- EXHAUST
- FUEL & AIR SYSTEMS
- ENGINE
- PRIMARY DRIVE
- TRANSMISSION & FINAL DRIVE
- GASKETS
- HANDLEBARS & CONTROL
- CABLES
- FOOT CONTROL
- INSTRUMENT & LIGHTING
- ELECTRICAL
- SECURITY & COVERS
- GENERAL ACCESSORIES & DISPLAY
- CROSS REFERENCE

AUDIO,  
VIDEO &  
NAVIGATION

INDIAN  
& VICTORY

WINDSHIELDS

SEATS &  
SISSY BARS

LUGGAGE

WHEELS

BRAKES

CHASSIS

SUSPENSION

SHEET METAL

EXHAUST

FUEL & AIR  
SYSTEMS

ENGINE

PRIMARY  
DRIVE

TRANSMISSION  
& FINAL DRIVE

GASKETS

HANDLEBARS  
& CONTROL

CABLES

FOOT  
CONTROL

INSTRUMENT  
& LIGHTING

ELECTRICAL

SECURITY  
& COVERS

GENERAL  
ACCESSORIES  
& DISPLAY

CROSS  
REFERENCE



Black Smoke  
ME1611



Dark Black Smoke  
ME1607

### MEMPHIS SHADES® EL PASO SPORTSHIELDS

The El Paso Sportshield offers plenty of protection with a wide variety of heights. From 13" to 19" above the headlight, the El Paso is the most versatile sportshield in the line up. What sets the El Paso apart is the lower cut outs. Designed to work on bikes with handlebar-mounted turn signals, the El Paso's cutouts also celebrate a minimalist style that looks great on your cruiser.

- Smooth design complements your bike
- Tapered windshield lower is ideal for handlebar-mounted turn signals
- Fits all round headlights
- Available in Solar (light tint with 72% visible light transmission), Black Smoke (black tint with 40% visible light transmission) and Dark Black Smoke (black tint with 25% visible light transmission)
- Made of Lucite® for excellent clarity and weather resistance
- Measures 20" W x 17" H or 19" H above headlight
- All hardware is CNC-machined billet aluminum and polished stainless steel
- No-Tool, detachable Trigger-Lock mounting kit, sold separately
- Made in USA



	Cutout	Height	Color	P/N
	7"	13"	Black Smoke	<b>ME1597</b>
	7"	13"	Dark Black Smoke	<b>ME1598</b>
	9"	13"	Dark Black Smoke	<b>ME1603</b>
	9"	13"	Solar	<b>ME1604</b>
	9"	15"	Dark Black Smoke	<b>ME1607</b>
	9"	15"	Solar	<b>ME1608</b>
	9"	17"	Black Smoke	<b>ME1611</b>
	9"	17"	Solar	<b>ME1615</b>

### MEMPHIS SHADES® DEL REY SPORTSHIELDS

The Del Rey is a minimalist shield for just the right amount of protection and style. With its 13" height from the top of the headlight cut-out, it is the smallest shield in our Sportshield family. If you are looking for a small shield for just the right amount of wind protection, the Del Rey is your answer.

- Small, sleek design that offers fair protection in a minimalist package
- Measures 15" W x 13" H above headlight
- Fits all round headlights
- Made of Lucite® for excellent clarity and weather resistance
- All hardware is CNC-machined billet aluminum and polished stainless steel
- No-Tool, detachable Trigger-Lock mounting kit, sold separately
- Made in USA



Color	P/N
Black Smoke	<b>ME1699</b>



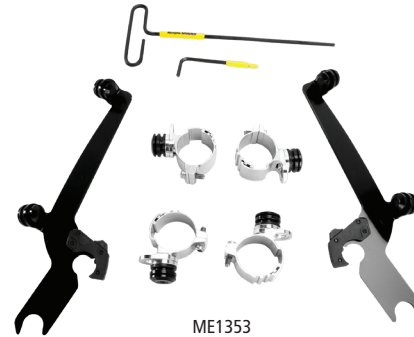

**MEMPHIS SHADES® SPORTSHIELDS TRIGGER-LOCK MOUNT KITS**

Polished Aluminum and Night Shades (Black) painted Trigger-Lock Mounting kits (no-tool removal).

- Compatible with Drop-Top Memphis Fats Windshields
- Made in USA



SOFTAIL	Year	Mount Kit Polished	Mount Kit Black	Plates Polished	Plates Black
FXLRS	20-22	ME1588 <sup>2</sup>			
FLSB	18-22	ME1588 <sup>3</sup>			
FXSB	13-17	ME1405	ME1372		
FXCW, FXCWC	08-11	ME1404	ME1371		
FXST, FXSTD, FXSTB	85-10				ME0542
FLSTN	05-17	ME1398 <sup>1</sup>			
FLSTN	05-17			ME0566	
FLSTF, FLSTFB, FLS	90-17	ME1398 <sup>1</sup>			
FLSTF, FLSTFB, FLS	90-17			ME0566	
FLSTC	86-17	ME1398 <sup>1</sup>			
FLSTC	86-17			ME0566	
<b>DYNA</b>					
FXD, FXDC, FXDB	06-17	ME1404	ME1371		
FXDWG	06-17	ME1405	ME1372		
FXDWG	93-05				ME0542
<b>FXR</b>					
FXR	82-94, 99-00				ME0541
<b>FX</b>					
FXWG	80-86				ME0542
FX	73-85				ME0541
<b>SPORTSTER</b>					
XL1200T	15-19	ME1386	ME1353		
XL1200C	11-19	ME1386	ME1353		
XL883L	11-19	ME1386	ME1353		

<sup>1</sup> Without O.E.M. light bar

<sup>2</sup> Requires Headlight Extension Kit P/N ME1713 and Headlight Trim Ring/Shroud Kit Mfgn/N MEB7231

<sup>3</sup> Requires 9" headlight cutout

- AUDIO, VIDEO & NAVIGATION
- INDIAN & VICTORY
- WINDSHIELDS**
- SEATS & SISSY BARS
- LUGGAGE
- WHEELS
- BRAKES
- CHASSIS
- SUSPENSION
- SHEET METAL
- EXHAUST
- FUEL & AIR SYSTEMS
- ENGINE
- PRIMARY DRIVE
- TRANSMISSION & FINAL DRIVE
- GASKETS
- HANDLEBARS & CONTROL
- CABLES
- FOOT CONTROL
- INSTRUMENT & LIGHTING
- ELECTRICAL
- SECURITY & COVERS
- GENERAL ACCESSORIES & DISPLAY
- CROSS REFERENCE

AUDIO, VIDEO & NAVIGATION



INDIAN & VICTORY

WINDSHIELDS

SEATS & SISSY BARS

LUGGAGE

WHEELS

BRAKES

CHASSIS

SUSPENSION

SHEET METAL

EXHAUST

FUEL & AIR SYSTEMS

ENGINE

PRIMARY DRIVE

TRANSMISSION & FINAL DRIVE

GASKETS

HANDLEBARS & CONTROL

CABLES

FOOT CONTROL

INSTRUMENT & LIGHTING

ELECTRICAL

SECURITY & COVERS

GENERAL ACCESSORIES & DISPLAY

CROSS REFERENCE



## MEMPHIS SHADES® SHOOTER HANDLEBAR MOUNT WINDSHIELD

The Shooter Windshield looks great on today's wide-body motorcycles and includes a two-point handlebar mount that accommodates 1" and 7/8" handlebars.

- Available in Solar (light tint with 72% visible light transmission)
- CNC-machined billet aluminum and polished stainless steel hardware
- Made of Lucite® for excellent clarity and weather resistance
- 19" W x 14" H
- Made in USA



Color	P/N
Black Smoke	ME1701
Dark Black Smoke	ME1702
Solar	ME0755



Black  
ME0997



Solar  
ME0998

## MEMPHIS SHADES® REPLACEMENT WINDSHIELDS FOR TOURING

The Memphis Shades® Replacement Windshields give you multiple height and tint options offered at a greater value than OEM equipment.

- Available in Black and Solar (light tint with 72% visible light transmission)
- Made of Lucite® for excellent optics and durability
- Use the OEM hardware for a perfect fit
- Made in USA



5" Windshield

HARLEY-DAVIDSON	Year	Color	P/N
FLHT, FLHX, FLHTCUTG	96-13	Black	ME0997
FLHT, FLHX, FLHTCUTG	96-13	Solar	ME0998

## MEMPHIS SHADES® SPOILER WINDSHIELD FOR TOURING

Be prepared to not be blown away; by wind turbulence that is. The Spoiler Windshield for your Harley-Davidson® Bagger was designed using industry leading CFD software and tested on thousands of miles of pavement to get real world feedback, the Spoiler Windshield is the perfect example of "Less is more." The spoiler area of the windshield diffuses and slows down the airflow, leaving you in a buffeting free zone to ride in comfort. In testing, the Spoiler Windshield acts over 2.5" higher than it is, meaning a 5" spoiler does the work of an 7.5" straight windshield and so on. Run a lower shield than you normally would with our Spoiler Windshield and enjoy a clear field of vision with no buffeting.

- Designed to be looked over, the spoiler windshield diffuses the air stream effectively slowing the flow, without buffeting
- Available in Smoke (medium bronze tint with 30% visible light transmission) and Dark Black Smoke (black tint with 25% visible light transmission)
- Mounts with O.E.M. hardware for perfect fit
- Made of Lucite® for best quality and durability
- Made in USA



TOURING	Year	Color	3"	6.5"	8.5"
FLHT, FLHX, FLHTCUTG	14-22	Smoke	ME1131		
ME1129					
FLTRX, FLTRXS, FLTRUSE	15-22	Dark Black Smoke		ME1116	
FLTR, FLTRX, FLTRU	04-13	Dark Black Smoke		ME1088	ME1092



Dark Smoke  
ME1116



Smoke  
ME1131



**MEMPHIS SHADES® REPLACEMENT PLASTIC FOR O.E.M. WINDSHIELDS**

Have a Harley-Davidson® that came from the factory with a windshield but need that extra bit of customization to make it perfect? The answer is Memphis Shades replacement plastics for your Harley-Davidson® O.E.M. Windshield. A value packed product, our replacement plastics are offered in our seven signature colors and many different sizes for most Harley-Davidson® motorcycles that come equipped with an O.E.M. windshield. Perfect fit, many options and industry exclusive mounting hole inserts to prevent over tightening issues, the Memphis Shades Replacement Windshields are the perfect addition for your Harley-Davidson®.

- No-Tool, detachable Trigger-Lock mounting kit, sold separately
- Made in USA

Note: These windshields do not fit all models be sure to check measurements first. Measurements are approximate, and center-to-center of holes. Bolt-to-bolt measurements will vary.

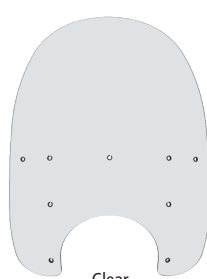

Clear  
ME0948

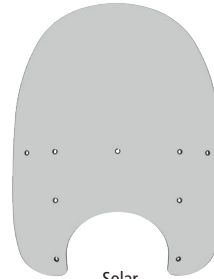

Solar  
ME0954

**Replacement Plastic for O.E.M. FLHR Windshield**

TOURING	Year	Color	15"	19"	21"
FLHR	94-22	Clear	<b>ME0801</b>		<b>ME0899</b>
<b>ME0948</b>					
FLHR	94-22	Solar			<b>ME0954</b>

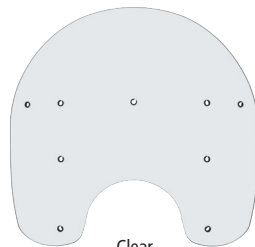

Clear  
ME0829

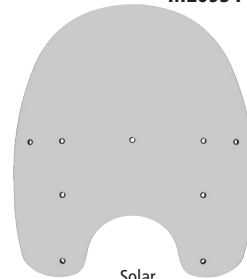

Solar  
ME0933

**Replacement Plastic for O.E.M. Detachable King Size Windshield**

SOFTAIL	Year	Color	15"	19"	21"
FLSTC	86-17	Clear	<b>ME0829</b>		
FLSTC	86-17	Solar		<b>ME0933</b>	<b>ME0961</b>
FLSTF	90-17	Clear	<b>ME0829</b>		
FLSTF	90-17	Solar		<b>ME0933</b>	<b>ME0961</b>
FLSTN	93-96, 05-17	Clear	<b>ME0829</b>		
FLSTN	93-96, 05-17	Solar		<b>ME0933</b>	<b>ME0961</b>

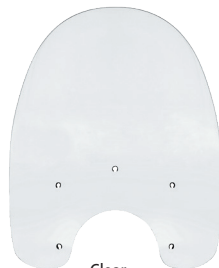

Clear  
ME0962

**Replacement Plastic for O.E.M. Detachable King Size Nostalgic Windshield**

SOFTAIL	Year	Color	21"
FLS	05-17	Clear	<b>ME0962</b>
FLSTF, FLSTFB	00-17	Clear	<b>ME0962</b>

- AUDIO, VIDEO & NAVIGATION
- INDIAN & VICTORY
- WINDSHIELDS**
- SEATS & SISSY BARS
- LUGGAGE
- WHEELS
- BRAKES
- CHASSIS
- SUSPENSION
- SHEET METAL
- EXHAUST
- FUEL & AIR SYSTEMS
- ENGINE
- PRIMARY DRIVE
- TRANSMISSION & FINAL DRIVE
- GASKETS
- HANDLEBARS & CONTROL
- CABLES
- FOOT CONTROL
- INSTRUMENT & LIGHTING
- ELECTRICAL
- SECURITY & COVERS
- GENERAL ACCESSORIES & DISPLAY
- CROSS REFERENCE

AUDIO,  
VIDEO &  
NAVIGATION



INDIAN  
& VICTORY

WINDSHIELDS

SEATS &  
SISSY BARS

**MEMPHIS SHADES®  
MEMPHIS FATS WINDSHIELDS REPLACEMENT STRAPS**

Replacement straps for the Memphis Fats Windshields.  
• Made in USA



WHEELS

**Finish** **P/N**  
Black **ME0579**

BRAKES

CHASSIS

SUSPENSION

SHEET METAL

**MEMPHIS SHADES®  
MEMPHIS SLIMS WINDSHIELDS REPLACEMENT STRAPS**

Replacement straps for Memphis Slims Windshields.  
• Made in USA



FUEL & AIR  
SYSTEMS

**Finish** **P/N**  
Black **ME1242**

ENGINE

PRIMARY  
DRIVE

TRANSMISSION  
& FINAL DRIVE

GASKETS

HANDLEBARS  
& CONTROL

CABLES

FOOT  
CONTROL

INSTRUMENT  
& LIGHTING

ELECTRICAL

SECURITY  
& COVERS

GENERAL  
ACCESSORIES  
& DISPLAY

CROSS  
REFERENCE

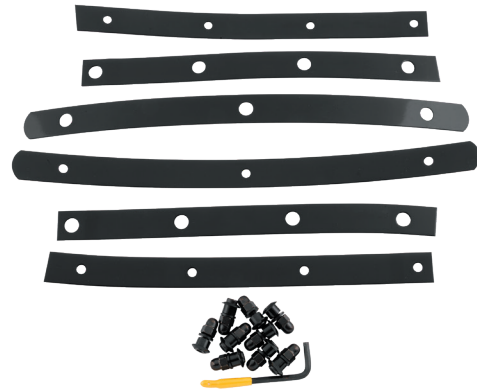
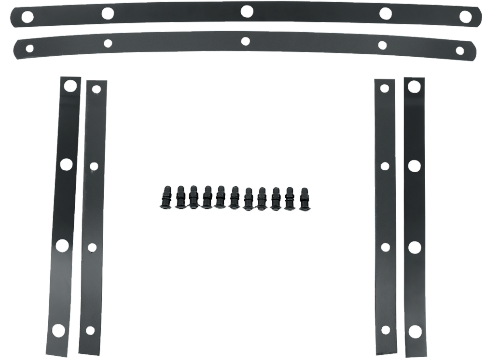

CustomAcces



304741



304762

**CUSTOM ACCES BATWING SML FAIRING**

The Batwing SML Fairing features a windscreen, formed around a black plastic shell that's designed to improve the overall aesthetic of the motorcycle, giving it a complete and custom look.

- Screen can be installed at two different heights
- Includes built-in hardware kit for installation

HARLEY-DAVIDSON	Year	Type	Color	P/N
XL833	09-22	Short	Clear	<b>304742</b>
XL833	09-22	Short	Smoke	<b>304741</b>
XL833	09-22	Tall	Clear	<b>304749</b>
XL833	09-22	Tall	Smoke	<b>304762</b>
XL1200NS	18-22	Short	Clear	<b>304742</b>
XL1200NS	18-22	Short	Smoke	<b>304741</b>
XL1200NS	18-22	Tall	Clear	<b>304749</b>
XL1200NS	18-22	Tall	Smoke	<b>304762</b>
XG750	15-20	Short	Clear	<b>304770</b>
XG750	15-20	Short	Smoke	<b>304769</b>
XG750	15-20	Tall	Clear	<b>304772</b>
XG750	15-20	Tall	Smoke	<b>304771</b>



304742



304788

**CUSTOM ACCES ANARCHY SEMI-FAIRING**

Made from highly impact-resistant materials with improved aerodynamic capacity, designed specifically around each motorcycle's individual design, blending perfectly to the headlight.

- Perfect combination of sportiness and protection
- Easy installation, includes assembly kit with hardware and detailed instructions
- 18.5" H x 10.6" W

HARLEY-DAVIDSON	Year	P/N
FXDB	06-17	<b>304574</b>
XL833	09-22	<b>304788</b>
XL1200NS	18-22	<b>304788</b>
XL1200X	15-22	<b>304573</b>



- AUDIO, VIDEO & NAVIGATION
- INDIAN & VICTORY
- WINDSHIELDS**
- SEATS & SISSY BARS
- LUGGAGE
- WHEELS
- BRAKES
- CHASSIS
- SUSPENSION
- SHEET METAL
- EXHAUST
- FUEL & AIR SYSTEMS
- ENGINE
- PRIMARY DRIVE
- TRANSMISSION & FINAL DRIVE
- GASKETS
- HANDLEBARS & CONTROL
- CABLES
- FOOT CONTROL
- INSTRUMENT & LIGHTING
- ELECTRICAL
- SECURITY & COVERS
- GENERAL ACCESSORIES & DISPLAY
- CROSS REFERENCE



*Custom Acces*

AUDIO, VIDEO & NAVIGATION

INDIAN & VICTORY

WINDSHIELDS

SEATS & SISSY BARS

LUGGAGE

WHEELS

BRAKES

CHASSIS

SUSPENSION

SHEET METAL

EXHAUST

FUEL & AIR SYSTEMS

ENGINE

PRIMARY DRIVE

TRANSMISSION & FINAL DRIVE

GASKETS

HANDLEBARS & CONTROL

CABLES

FOOT CONTROL

INSTRUMENT & LIGHTING

ELECTRICAL

SECURITY & COVERS

GENERAL ACCESSORIES & DISPLAY

CROSS REFERENCE



**CUSTOM ACCES DARK NIGHT SEMI-FAIRING**

If you're looking for a sporty semi-fairing, the Custom Access Dark Night is the perfect option. Featuring a smoke windscreen and semi-fairing with a gloss black finish, that fits the contours of the headlight perfectly.

- Includes install kit with detailed instructions
- 18.50" H x 18.11" W

HARLEY-DAVIDSON	Year	Color	P/N
FXDB	06-17	Smoke	<b>305046</b>
FXDB	06-17	Dark Smoke	<b>305045</b>
XL833	09-22	Smoke	<b>304796</b>
XL833	09-22	Dark Smoke	<b>304795</b>
XL1200NS	18-22	Smoke	<b>304796</b>
XL1200NS	18-22	Dark Smoke	<b>304795</b>
XG750	15-20	Smoke	<b>304798</b>
XG750	15-20	Dark Smoke	<b>304797</b>



**CUSTOM ACCES FREE SPIRIT SEMI-FAIRING**

Renew the appearance of your motorcycle, while creating an additional barrier to protect against the wind. Designed in true HD-style, the Free Spirit Semi-Fairing is available in a gloss or matte black finish that's specifically designed to match the Harley-Davidson Sportster.

- Includes mounting kit and detailed instructions
- 13.98" H x 10.4" W

HARLEY-DAVIDSON	Year	Color	P/N
XL833	05-22	Black	<b>304799</b>



**WORLDWIDE LEADER  
IN WINDSHIELD  
TECHNOLOGY™**

- AUDIO, VIDEO & NAVIGATION
- INDIAN & VICTORY
- WINDSHIELDS**
- SEATS & SISSY BARS
- LUGGAGE
- WHEELS
- BRAKES
- CHASSIS
- SUSPENSION
- SHEET METAL
- EXHAUST
- FUEL & AIR SYSTEMS
- ENGINE
- PRIMARY DRIVE
- TRANSMISSION & FINAL DRIVE
- GASKETS
- HANDLEBARS & CONTROL
- CABLES
- FOOT CONTROL
- INSTRUMENT & LIGHTING
- ELECTRICAL
- SECURITY & COVERS
- GENERAL ACCESSORIES & DISPLAY
- CROSS REFERENCE

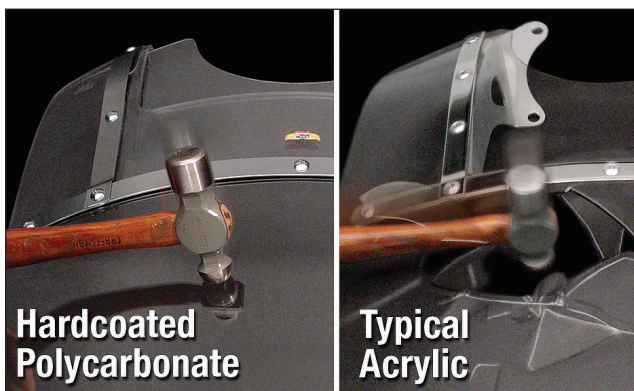

**POLYCARBONATE STRENGTH**

- 10x Greater impact resistance than high-impact acrylic!
  - 20x Greater impact resistance than typical acrylic!
- Hardcoated polycarbonate (left) resists damage from a ball-peen hammer applied at full force. However, an acrylic shield (right) easily shatters into sharp slivers.

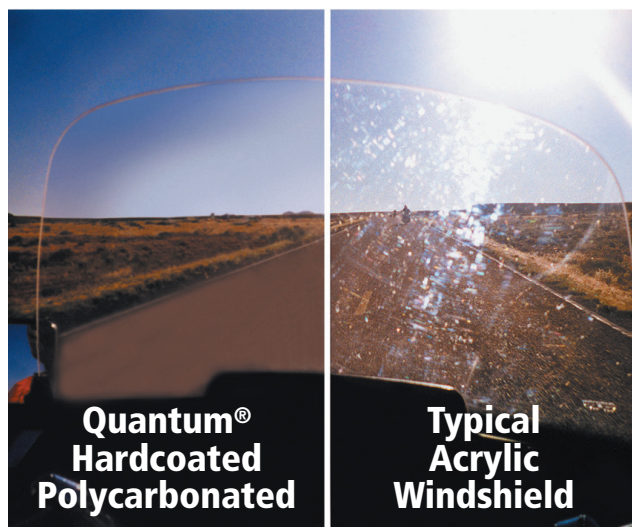

**QUANTUM® SCRATCH RESISTANCE**

- 10x Greater scratch resistance than standard hardcoating!
  - 30x greater scratch resistance than typical acrylic!
- Quantum® hardcoated polycarbonate strongly resists scratches and abrasion while acrylic material scratches very easily.

Quantum® is an exclusive product of National Cycle Inc.



**PRECISION FORMING AND QUALITY ROUTING**

The full-bodied, dimensional designs provide better airflow and protection for the rider and the passenger and is another example of national Cycle's no-compromise approach to quality.

All holes and mount points are precisely drilled for perfect fit and alignment. All windshield edges are routed for a smooth radiused finish.

**3-YEAR MANUFACTURER'S WARRANTY**

All National Cycle polycarbonate windshields are made in the USA and are covered by their exclusive 3-Year Warranty against breakage!



## NATIONAL CYCLE WINDSHIELD FAMILIES

- MOUNT KIT INCLUDED
- MOUNT KIT SOLD SEPARATELY
- PC** HARDCOATED POLYCARBONATE
- 3** 3-YEAR WARRANTY

### REPLACEMENT WINDSCREEN



#### VSTREAM® WINDSCREEN

- Aeroacoustic performance
- Patented "V" shape
- Helps reduce turbulent air
- Offered in multiple sizes and tints

**3**

VStream Windcreens ON PAGE 227



#### WAVE® WINDSCREEN

- Stylish, sleek and sexy
- Direct replacement for O.E.M.
- Available in three sizes and tints

**3**

Wave Windcreens ON PAGE 228



#### REPLACEMENT SCREENS

- Precision cut and formed
- Taller sizes for etter wind protection
- Mounts with O.E.M. hardware
- Easy installation

**3**

Replacemnt Screens ON PAGE 229

### CUSTOM CRUISER WINDSHIELD



#### SWITCHBLADE® WINDSHIELDS

- Quick release fork mount windshield
- Stainless steel, chrome steel hardware
- Selection of four styles and sizes
- The ultimate cruiser windshield

**3**

SwitchBlade Windshields ON PAGE 231



#### SPARTAN® WINDSHIELDS

- Quick release fork mount windshield
- Selection of four styles and sizes
- Adjustable fit to many makes and models
- Long legacy of fitment applications

**3**

Spartan Windshields ON PAGE 234



#### WAVE QR® FAIRINGS

- Quick release fork mount fairings
- Uses SwitchBlade mount kits
- Unique streamlined styling
- Rake adjustable

**3**

Wave QR Fairings ON PAGE 236



#### HEAVY DUTY™ WINDSHIELDS

- Fixed fork mount windshield
- Selection of six styles and sizes
- Adjustable to fit many models
- Long legacy of fitment applications

**3**

Heavy Duty Windshields ON PAGE 237

### CUSTOM CRUISER WINDSHIELD



#### VINTAGE-STYLE BEADED WINDSHIELDS

- Beaded edge and steel ring are retained for an authentic, period correct appearance
- Available in Clear, Black, Blue and Red

**3**

Gladiator Windshields ON PAGE 240

### UNIVERSAL MOUNT WINDSHIELD



#### FLYSCREEN® WINDSHIELDS

- Classic, traditional style
- Fits a wide range of models
- Light tint or dark tint screens
- Chrome or black hardware

**3**

Flyscreen Windshields ON PAGE 241



#### MOHAWK™ WINDSHIELDS

- Stylized small windshield
- Uses Flyscreen® mount hardware
- Taller and wider than Flyscreen®
- Chrome or black hardware

**3**

Mohawk Windshields ON PAGE 242



#### STREET SHIELD™

- Compact yet effective windshield
- Quick release or fixed mount options
- Four-point mount system
- Highly adjustable

**3**

Street Shields ON PAGE 243



#### DEFLECTOR SCREEN™

- World's most copied windshield
- Quick release or fixed mount options
- Two-point mount system
- Highly adjustable

**3**

Deflector Screens ON PAGE 245



#### PLEXIFAIRING™

- Quick release clear fairings
- Great upper torso and hand protection
- Extended lowers reduced turbulence
- Rugged construction, quality materials
- Highly adjustable

Plexifairings ON PAGE 247



#### DAKOTA 3.0™ WINDSHIELDS

- Adjustable fork mount windshield
- Economically priced
- Available in two heights
- High impact acrylic construction

Dakota 3.0 Windshields ON PAGE 246

WINDSHIELDS

SEATS & SISSY BARS

LUGGAGE

WHEELS

BRAKES

CHASSIS

SUSPENSION

SHEET METAL

EXHAUST

FUEL & AIR SYSTEMS

ENGINE

PRIMARY DRIVE

TRANSMISSION & FINAL DRIVE

GASKETS

HANDLEBARS & CONTROL

CABLES

FOOT CONTROL

INSTRUMENT & LIGHTING

ELECTRICAL

SECURITY & COVERS

GENERAL ACCESSORIES & DISPLAY

CROSS REFERENCE



**NATIONAL CYCLE® VSTREAM WINDSCREEN**

The revolutionary VStream® Windscreen gets its name from the unique shape and dimensional contour designed and engineered into the windscreen. The patented "V" profile helps push the turbulent wind out and away from the side of the rider's head, producing a quieter and more comfortable riding experience for both the rider and the passenger. Designed specifically for each model bike to ensure optimum performance and perfect fit using the O.E.M. mounting hardware. 4.5mm polycarbonate for outstanding impact strength 20x greater than acrylic. Coated with National Cycle's Quantum™ hard coating or FMR hard coating, depending on windscreen shape, for unbeatable scratch resistance. Dark 89% tint reduces glare in bright sun.

- 40% thicker than stock
- All FLTR VStream® Windscreens include metal compression limiters that spread the load for long life and durability
- Three-year manufacturer's warranty against breakage
- Made in USA



All VStream Windscreens are manufactured in the USA from thick, durable hardcoated polycarbonate and are covered by National Cycle's exclusive 3-Year Warranty against breakage!

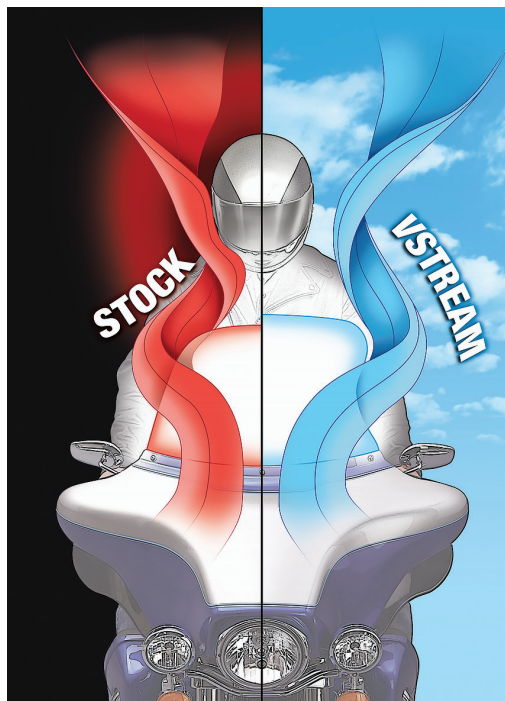

**VStream®**



National Cycle's exclusive Quantum® hardcoating takes motorcycle windshields a quantum leap forward. These are the strongest, most scratch resistant windshields available anywhere. Quantum® is an exclusive product of National Cycle Inc.



HARLEY-DAVIDSON	Year	Color	Height	Mfg/N	P/N
FLHT, FLHX	14-22	Clear	14.5"	N20407	<b>552509</b>
FLHT, FLHX	14-22	Clear	11.5"	N20408	<b>552517</b>
FLHT, FLHX	14-22	Light Tint	9.5"	N20409	<b>552516</b>
FLHT, FLHX	14-22	Light Tint	7.5"	N20410	<b>552515</b>
FLHT, FLHX	14-22	Dark Tint	7.25"	N20411	<b>552514</b>
FLHT, FLHTCUTG, FLHX	96-13	Clear	17.00"	N20401	<b>552130</b>
FLHT, FLHTCUTG, FLHX	96-13	Clear	14.00"	N20403	<b>552131</b>
FLHT, FLHTCUTG, FLHX	96-13	Dark Tint	10.75"	N20404	<b>552132</b>
FLHT, FLHTCUTG, FLHX	96-13	Light Tint	10.75"	N20406	<b>552138</b>
FLHT, FLHTCUTG, FLHX	96-13	Dark Tint	7.25"	N20405	<b>552133</b>
FLTR, FLTRU, FLTRXS	15-22	Clear	16.00"	N20431	<b>551197</b>
FLTR, FLTRU, FLTRXS	15-22	Light Tint	12.5"	N20432	<b>551198</b>
FLTR, FLTRU, FLTRXS	15-22	Dark Tint	9.00"	N20433	<b>551199</b>
FLTR, FLTRU, FLTRX	98-13	Clear	18.00"	N20421	<b>552134</b>
FLTR, FLTRU, FLTRX	98-13	Clear	15.25"	N20422	<b>552135</b>
FLTR, FLTRU, FLTRX	98-13	Light Tint	12.00"	N20425	<b>552137</b>
FLTR, FLTRU, FLTRX	98-13	Dark Tint	9.25"	N20423	<b>552136</b>
RA1250 Pan America	21-22	Clear	13.75"	N20412	<b>553066</b>
RA1250 Pan America	21-22	Clear w/Beaded Edge	16.38"	N20413	<b>553067</b>
RA1250 Pan America	21-22	Clear	13.75"	N20414	<b>553068</b>
RA1250 Pan America	21-22	Clear w/Plain Edge	16.38"	N20415	<b>553069</b>



FLTR, FLTRX, FLTRU, FLTRXS:  
Centerline measurement from top of fairing edge to top of screen  
FLHT, FLHX:  
Centerline measurement from bottom center mount hole to top of screen

Shield Wash and Rainzip **ON PAGE 248**

- AUDIO, VIDEO & NAVIGATION
- INDIAN & VICTORY
- WINDSHIELDS**
- SEATS & SISSY BARS
- LUGGAGE
- WHEELS
- BRAKES
- CHASSIS
- SUSPENSION
- SHEET METAL
- EXHAUST
- FUEL & AIR SYSTEMS
- ENGINE
- PRIMARY DRIVE
- TRANSMISSION & FINAL DRIVE
- GASKETS
- HANDLEBARS & CONTROL
- CABLES
- FOOT CONTROL
- INSTRUMENT & LIGHTING
- ELECTRICAL
- SECURITY & COVERS
- GENERAL ACCESSORIES & DISPLAY
- CROSS REFERENCE



AUDIO, VIDEO & NAVIGATION

INDIAN & VICTORY

WINDSHIELDS

SEATS & SISSY BARS

LUGGAGE

WHEELS

BRAKES

CHASSIS

SUSPENSION

SHEET METAL

EXHAUST

FUEL & AIR SYSTEMS

ENGINE

PRIMARY DRIVE

TRANSMISSION & FINAL DRIVE

GASKETS

HANDLEBARS & CONTROL

CABLES

FOOT CONTROL

INSTRUMENT & LIGHTING

ELECTRICAL

SECURITY & COVERS

GENERAL ACCESSORIES & DISPLAY

CROSS REFERENCE



Wave Screens are manufactured in the USA from thick, durable hardcoated polycarbonate and are covered by National Cycle's exclusive 3-Year Warranty against breakage!



National Cycle's exclusive Quantum<sup>®</sup> hardcoating takes motorcycle windshields a quantum leap forward. These are the strongest, most scratch resistant windshields available anywhere. Quantum<sup>®</sup> is an exclusive product of National Cycle Inc.



All FLTR Wave Windshields include metal compression limiters that spread the load for long life and durability.

## NATIONAL CYCLE<sup>®</sup> WAVE WINDSCREENS

Sleek, Stylish, Sexy...It's the new Wave<sup>®</sup>. Ride it!

- 4.5mm polycarbonate for outstanding impact strength 20x greater than acrylic
- 40% thicker than stock
- Quantum<sup>™</sup> hard coating provides unbeatable scratch resistance
- Three-year manufacturer's warranty against breakage
- Made in USA



50 feet (15.25 meters)



Note: For just about every combination of rider and motorcycle, National Cycle manufactures a quality windscreen. It's important, however, to choose the right height. This 5'10" rider is able to look over the 7.75" Wave<sup>®</sup> Windscreen to see the road ahead at a distance of 50 feet (15.25 meters), which is the minimum distance National Cycle recommends.

552580



552581



552582



### HARLEY-DAVIDSON

	Year	Style	Color	Height	Mfg/N	P/N
FLHT, FLHTCUTG, FLHX	96-13	Wave Tall	Clear	10.00"	N27401	<b>552580</b>
FLHT, FLHTCUTG, FLHX	96-13	Wave Standard	Light Tint	7.75"	N27402	<b>552581</b>
FLHT, FLHTCUTG, FLHX	96-13	Wave Low	Dark Tint	5.25"	N27403	<b>552582</b>
FLTR, FLTRU, FLTRX	98-13	Wave Standard	Light Tint	8.25"	N27405	<b>552585</b>
FLTR, FLTRU, FLTRX	98-13	Wave Low	Dark Tint	6.25"	N27406	<b>552586</b>



Wave Windshields are measured from the top of the fairing in a vertical line level to the top of the screen.

Shield Wash and Rainzip **ON PAGE 248**



**NATIONAL CYCLE®  
CUSTOM REPLACEMENT WINDSCREEN FOR FLHT, FLHX**

This is one tough little windscreen. The National Cycle® Custom Replacement Windscreens are made from sturdy polycarbonate which is 23x better than acrylic when it comes to impact strength. The exclusive Quantum® hardcoat for scratch resistance performs 10x better than FMR coating and 30x better than acrylic replacement screens.

- 3.0mm polycarbonate construction
- Uses O.E.M. hardware
- Three-year manufacturer's warranty against breakage
- Made in USA



HARLEY-DAVIDSON	Year	Style	P/N
FLHT, FLHX	14-22	Fly Boy	552618
FLHT, FLHX	14-22	Bad Boy	552619
FLHT, FLHX	14-22	Gee Bee	552620

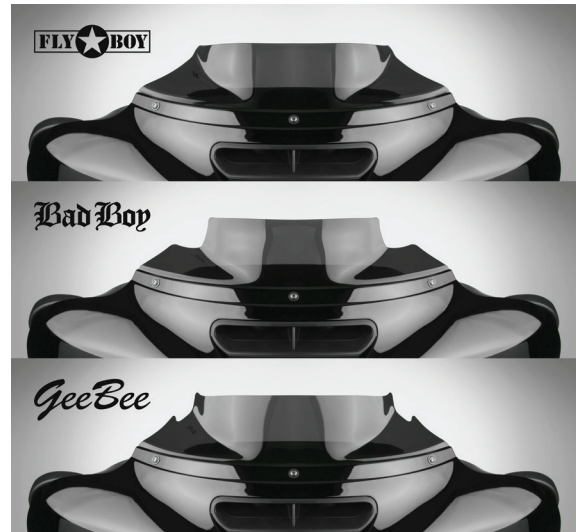

Fly Boy



Bad Boy



Gee Bee

Replacement Screens are manufactured in the USA from thick, durable hardcoated polycarbonate and are covered by National Cycle's exclusive 3-Year Warranty against breakage!



National Cycle's exclusive Quantum® hardcoating takes motorcycle windshields a quantum leap forward. These are the strongest, most scratch resistant windshields available anywhere. Quantum® is an exclusive product of National Cycle Inc.



Measured on centerline from top of fairing edge to top of screen.

- AUDIO, VIDEO & NAVIGATION
- INDIAN & VICTORY
- WINDSHIELDS**
- SEATS & SISSY BARS
- LUGGAGE
- WHEELS
- BRAKES
- CHASSIS
- SUSPENSION
- SHEET METAL
- EXHAUST
- FUEL & AIR SYSTEMS
- ENGINE
- PRIMARY DRIVE
- TRANSMISSION & FINAL DRIVE
- GASKETS
- HANDLEBARS & CONTROL
- CABLES
- FOOT CONTROL
- INSTRUMENT & LIGHTING
- ELECTRICAL
- SECURITY & COVERS
- GENERAL ACCESSORIES & DISPLAY
- CROSS REFERENCE

AUDIO, VIDEO & NAVIGATION



**national cycle**

INDIAN & VICTORY

WINDSHIELDS

SEATS & SISSY BARS

LUGGAGE

WHEELS

BRAKES

CHASSIS

SUSPENSION

SHEET METAL

EXHAUST

FUEL & AIR SYSTEMS

ENGINE

PRIMARY DRIVE

TRANSMISSION & FINAL DRIVE

GASKETS

HANDLEBARS & CONTROL

CABLES

FOOT CONTROL

INSTRUMENT & LIGHTING

ELECTRICAL

SECURITY & COVERS

GENERAL ACCESSORIES & DISPLAY

CROSS REFERENCE

## NATIONAL CYCLE®

### DIRECT REPLACEMENT SCREENS FOR FLHR

Direct replacement for stock O.E.M. windscreen. Quantum™ hard coating provides unbeatable scratch resistance 10x greater than the stock FMR hard coating.

- 4.0mm polycarbonate construction; 33% thicker than stock
- D.O.T.-approved
- Three-year manufacturer's warranty against breakage
- Made in USA



HARLEY-DAVIDSON	Year	Color	Height	P/N
FLHR, FLHRC	94-22	Clear	20.00"	<b>552229</b>
FLSTC	00-15	Clear	20.00"	<b>552569</b>



Replacement Screens are manufactured in the USA from thick, durable hardcoated polycarbonate and are covered by National Cycle's exclusive 3-Year Warranty against breakage!



National Cycle's exclusive Quantum® hardcoating takes motorcycle windshields a quantum leap forward. These are the strongest, most scratch resistant windshields available anywhere. Quantum® is an exclusive product of National Cycle Inc.

**National Cycle's replacement screens are 33% thicker than the O.E.M. screens..**

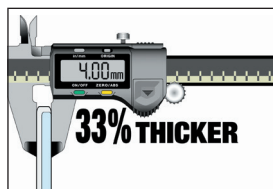

Measured from the top of the headlight cutout to the top of the screen and horizontally across the back at the widest point.



**Manufacturing quality is evident in the precision cut, smooth radiused edges of all National Cycle windshields.**



552150



552152



## NATIONAL CYCLE® FAIRING WINDSCREENS

An exact replacement for early FLH/FLHT models.

- Made from FMR hard-coated Lexan® polycarbonate
- Clear and tint options available for all years
- D.O.T.-approved
- Three-year manufacturer's warranty against breakage
- Made in USA



HARLEY-DAVIDSON	Year	Color	Height	P/N
FLHT, FLHTC	96-13	Clear	12.75"	<b>552150</b>
FLHT, FLHTC	96-13	Light Tint	12.75"	<b>552151</b>
FLHT, FLHTC	96-13	Dark Tint	8.75"	<b>552152</b>
FLHT, FLHTC	86-95	Clear	11.75"	<b>552042</b>
FLHT, FLHTC	86-95	Light Tint	6.25"	<b>552043</b>
FLH	60-85	Clear	17.25"	<b>552030<sup>1</sup></b>
FLH	60-85	Light Tint	7.00"	<b>552041<sup>1</sup></b>

<sup>1</sup>With factory bar mount fairing



Measured on centerline from top of fairing edge to top of screen.



**SWITCHBLADE® WINDSHIELDS: ON OR OFF IN LESS THAN FIVE SECONDS... WITH NO TOOLS!**



SwitchBlade Windshields are manufactured in the USA from thick, durable hardcoated polycarbonate and are covered by National Cycle's exclusive 3-Year Warranty against breakage!



National Cycle's exclusive Quantum® hardcoating takes motorcycle windshields a quantum leap forward. These are the strongest, most scratch resistant windshields available anywhere. Quantum® is an exclusive product of National Cycle Inc.

**NATIONAL CYCLE® SWITCHBLADE QUICK RELEASE WINDSHIELDS**

Premium, quick-release hardware that's built to last. Just grab the shield, and pull it off your bike...no tools required! Stainless steel mount brackets glide easily on and off the stainless steel mount spools. 4.0mm thick Lexan® polycarbonate with 20x more impact resistance than other acrylic or Lucite® plastic windshields. Hardware is made from thick-gauge material with beveled edge detailing and finished in high polish or bright chrome. Exclusive Quantum™ hard coating provides 10-30x better scratch resistance than any other windshield material on the market. Switch your style: four sizes and styles for every bike and any rider, and they all fit your mount kit.

- Three-year manufacturer's warranty against breakage
- Made in USA

Note: Mount Kits are sold separately.



**Switchblade® 2-Up®**

- Features maximum wind and weather protection
- Best windshield for long distance touring
- Add a set of Chrome Lower Deflectors and enjoy miles of whisper-quiet riding

**Switchblade® Chopped™**

- Like the 2-Up, but with a chopped top and a slimmer waist
- Great wind protection while allowing a clear view over the top
- Excellent choice for shorter riders or cruisers with lowered rear suspension

**Switchblade® Shorty®**

- Slim profile with aggressive styling
- Abbreviated contours look great on performance cruisers and street rods
- An ideal choice as your "daily rider" in warmer weather

**Switchblade® Deflector™**

- Keeps wind blast off your chest
- The perfect shield for urban cruising
- Features patented Rake Adjust™ for changing windscreen angle
- Rake adjustable!

AUDIO, VIDEO & NAVIGATION

INDIAN & VICTORY

WINDSHIELDS

SEATS & SISSY BARS

LUGGAGE

WHEELS

BRAKES

CHASSIS

SUSPENSION

SHEET METAL

EXHAUST

FUEL & AIR SYSTEMS

ENGINE

PRIMARY DRIVE

TRANSMISSION & FINAL DRIVE

GASKETS

HANDLEBARS & CONTROL

CABLES

FOOT CONTROL

INSTRUMENT & LIGHTING

ELECTRICAL

SECURITY & COVERS

GENERAL ACCESSORIES & DISPLAY

CROSS REFERENCE





## SWITCHBLADE MOUNT KITS

### How Do SwitchBlade® Windshields and Mount Kits Fit Your Bike?

Each SwitchBlade® windshield and mount kit is model-specific. These are not “universal” fitments that work fine on some models and work poorly on others.

When you order the mount kit and any SwitchBlade® windshield for your model bike, you can be sure it will fit like it was custom made for your bike, because it was!



**SwitchBlade® Mount Kits for Exposed Fork Tubes**



**SwitchBlade® Mount Kits for Nacelle-Style Fork Tube Covers**

### How to Select the Correct SwitchBlade® Windshield and Mount Kits to Fit your Bike

1. Determine your motorcycle’s make, model and year.
2. Choose the appropriate SwitchBlade® Mount Kit (see application chart on page 233).
3. Determine what style windshield best fits you.
  - Consider your height and saddle position
  - Determine your riding habits: Daily commutes? Long trips? Weekend rides?
  - Do you want maximum protection? A sporty look? Or a combination?
4. Pick the appropriate SwitchBlade® 2-up, Chopped, Shorty or Deflector windshield.

Still can’t decide? Choose two or even all four of the SwitchBlade® shields. With the Quick Release SwitchBlade® Mount Kit, you can change your windshield as quickly as you change your mind.

## SWITCHBLADE WINDSHIELD DIMENSIONS

GASKETS	P/N	Overall Height	Cutout To Top	Overall Width	P/N	Overall Height	Cutout To Top	Overall Width	
HANDLEBARS & CONTROL	<b>SwitchBlade® 2-Up Clear</b>				<b>SwitchBlade® Deflector Clear Tint</b>				
	<b>558031</b>	26.40" (67.0cm)	19.50" (49.5cm)	23.00" (58.4cm)	<b>558039</b>	<b>558040</b>	14.50" (36.8cm)	12.00" (30.5cm)	13.50" (34.3cm)
					<b>558041</b>	<b>558042</b>	14.50" (36.8cm)	12.00" (30.5cm)	13.50" (34.3cm)
CABLES				<b>558043</b>	<b>558044</b>	14.50" (36.8cm)	12.00" (30.5cm)	13.50" (34.3cm)	
FOOT CONTROL									
INSTRUMENT & LIGHTING	<b>SwitchBlade® Chopped Clear</b>								
	<b>558106</b>	21.10" (53.6cm)	15.60" (39.6cm)	22.20" (56.3cm)					
ELECTRICAL									
SECURITY & COVERS									
GENERAL ACCESSORIES & DISPLAY									
CROSS REFERENCE									



Measured from the top of the headlight cutout to the top of the screen and horizontally across the back at the widest point.



**NATIONAL CYCLE® SWITCHBLADE QUICK RELEASE WINDSHIELDS** continued from previous page.

- AUDIO, VIDEO & NAVIGATION
- INDIAN & VICTORY
- WINDSHIELDS**
- SEATS & SISSY BARS
- LUGGAGE
- WHEELS
- BRAKES
- CHASSIS
- SUSPENSION
- SHEET METAL
- EXHAUST
- FUEL & AIR SYSTEMS
- ENGINE
- PRIMARY DRIVE
- TRANSMISSION & FINAL DRIVE
- GASKETS
- HANDLEBARS & CONTROL
- CABLES
- FOOT CONTROL
- INSTRUMENT & LIGHTING
- ELECTRICAL
- SECURITY & COVERS
- GENERAL ACCESSORIES & DISPLAY
- CROSS REFERENCE

TOURING	Year	2-Up Clear	Chopped Clear	Chopped Tint	Deflector Clear	Deflector Tint	Chrome Lowers	Mount Kit
FLHR	94-22			557497 <sup>1</sup>				558029 <sup>1</sup>
FLHRC	96-13			557497 <sup>1</sup>				558029 <sup>1</sup>
FLHRS	04-07			557497 <sup>1</sup>				558029 <sup>1</sup>
<b>SOFTAIL</b>								
FLSS	16-17	557492 <sup>2</sup>		557496 <sup>2</sup>			558046 <sup>2</sup>	558027 <sup>2</sup>
FLS	12-17	557492 <sup>2</sup>		557496 <sup>2</sup>			558046 <sup>2</sup>	558027 <sup>2</sup>
FLSTC	87-17	557492 <sup>2</sup>		557496 <sup>2</sup>	558043 <sup>2</sup>	558044 <sup>2</sup>	558046 <sup>2</sup>	558027 <sup>2</sup>
FLSTC	87-17	557492 <sup>3</sup>		557496 <sup>3</sup>	558043 <sup>3</sup>	558044 <sup>3</sup>	558046 <sup>3</sup>	558028 <sup>3</sup>
FLSTN/H	94-96	557492 <sup>2</sup>		557496 <sup>2</sup>	558043 <sup>2</sup>	558044 <sup>2</sup>	558046 <sup>2</sup>	558027 <sup>2</sup>
FLSTN/H	94-96	557492 <sup>3</sup>		557496 <sup>3</sup>	558043 <sup>3</sup>	558044 <sup>3</sup>	558046 <sup>3</sup>	558028 <sup>3</sup>
FLSTN	1993	557492 <sup>2</sup>		557496 <sup>2</sup>	558043 <sup>2</sup>	558044 <sup>2</sup>	558046 <sup>2</sup>	558027 <sup>2</sup>
FLSTN	1993	557492 <sup>3</sup>		557496 <sup>3</sup>	558043 <sup>3</sup>	558044 <sup>3</sup>	558046 <sup>3</sup>	558028 <sup>3</sup>
FLST	2006	557492 <sup>3</sup>		557496 <sup>3</sup>	558043 <sup>3</sup>	558044 <sup>3</sup>	558046 <sup>3</sup>	558028 <sup>3</sup>
FLST	86-90	557492 <sup>2</sup>		557496 <sup>2</sup>	558043 <sup>2</sup>	558044 <sup>2</sup>	558046 <sup>2</sup>	558027 <sup>2</sup>
FLST	86-90	557492 <sup>3</sup>		557496 <sup>3</sup>	558043 <sup>3</sup>	558044 <sup>3</sup>	558046 <sup>3</sup>	558028 <sup>3</sup>
FLSTF/B	90-17	557492 <sup>2</sup>		557496 <sup>2</sup>	558043 <sup>2</sup>	558044 <sup>2</sup>	558046 <sup>2</sup>	558027 <sup>2</sup>
FLSTF/B	90-17	557492 <sup>3</sup>		557496 <sup>3</sup>	558043 <sup>3</sup>	558044 <sup>3</sup>	558046 <sup>3</sup>	558028 <sup>3</sup>
FXST	84-90, 99-12	558031	557495		558041	558042	558045	558026
FXSTC	87-99, 07-10	558031	557495		558041	558042	558045	558026
FXSTB	99-09	558031	557495		558041	558042		558026
FXSTD	00-07	558031	557495		558041	558042	558045	558026
FXCW/C	08-11	557493	558106				558045	557842
<b>DYNA</b>								
FXDB	06-16	557493 <sup>4</sup>	558106 <sup>4</sup>				558045 <sup>4</sup>	557842 <sup>4</sup>
FXDC	06-14	557493 <sup>4</sup>	558106 <sup>4</sup>				558045 <sup>4</sup>	557842 <sup>4</sup>
FXD	06-10	557493 <sup>4</sup>	558106 <sup>4</sup>				558045 <sup>4</sup>	557842 <sup>4</sup>
FXDL	06-09	557493 <sup>4</sup>	558106 <sup>4</sup>				558045 <sup>4</sup>	557842 <sup>4</sup>
FXDS	94-00	557491 <sup>5</sup>			558039 <sup>5</sup>	558040 <sup>5</sup>	558045 <sup>5</sup>	558025 <sup>5</sup>
FXD/LX/C	93-05	557491 <sup>5</sup>			558039 <sup>5</sup>	558040 <sup>5</sup>	558045 <sup>5</sup>	558025 <sup>5</sup>
FXDWG	06-08, 10-17	558110 <sup>4</sup>					558045 <sup>4</sup>	557842 <sup>4</sup>
FXDWG	93-05	558031 <sup>6</sup>			558041 <sup>6</sup>	558042 <sup>6</sup>	558045 <sup>6</sup>	558026 <sup>6</sup>
<b>FXR</b>								
FXR/S	88-94	557491 <sup>5</sup>			558039 <sup>5</sup>	558040 <sup>5</sup>	558045 <sup>5</sup>	558025 <sup>5</sup>
<b>FX</b>								
FXLR	88-94	557491 <sup>5</sup>			558039 <sup>5</sup>	558040 <sup>5</sup>	558045 <sup>5</sup>	558025 <sup>5</sup>
FXWG	80-85	558031 <sup>6</sup>	557495 <sup>6</sup>		558041 <sup>6</sup>	558042 <sup>6</sup>	558045 <sup>6</sup>	558026 <sup>6</sup>
<b>SPORTSTER</b>								
XL1200V	12-16	557491 <sup>5</sup>			558039 <sup>5</sup>	558040 <sup>5</sup>	558045 <sup>5</sup>	558025 <sup>5</sup>
XL1200N/XL883N	07-22	557491 <sup>5</sup>			558039 <sup>5</sup>	558040 <sup>5</sup>	558045 <sup>5</sup>	558025 <sup>5</sup>
XL1200R/XL883R	02-13	557491 <sup>5</sup>			558039 <sup>5</sup>	558040 <sup>5</sup>	558045 <sup>5</sup>	558025 <sup>5</sup>
XL1200L	06-11	557491 <sup>5</sup>			558039 <sup>5</sup>	558040 <sup>5</sup>	558045 <sup>5</sup>	558025 <sup>5</sup>
XL1200/XL883	04-10	557491 <sup>5</sup>			558039 <sup>5</sup>	558040 <sup>5</sup>	558045 <sup>5</sup>	558025 <sup>5</sup>
XL1200C/XL883C	96-10	557491 <sup>5</sup>			558039 <sup>5</sup>	558040 <sup>5</sup>	558045 <sup>5</sup>	558025 <sup>5</sup>
XLH1200/XLH883	88-03	557491 <sup>5</sup>			558039 <sup>5</sup>	558040 <sup>5</sup>	558045 <sup>5</sup>	558025 <sup>5</sup>
XL1200S	96-03	557491 <sup>5</sup>			558039 <sup>5</sup>	558040 <sup>5</sup>	558045 <sup>5</sup>	558025 <sup>5</sup>
XL883L	05-10	557491 <sup>5</sup>			558039 <sup>5</sup>	558040 <sup>5</sup>	558045 <sup>5</sup>	558025 <sup>5</sup>

<sup>1</sup> With or without H-D light bar installed      <sup>4</sup> With 49mm fork tubes  
<sup>2</sup> With no H-D light bar installed                <sup>5</sup> With 39mm fork tubes  
<sup>3</sup> With H-D light bar installed                      <sup>6</sup> With 41mm fork tubes

**NATIONAL CYCLE SWITCHBLADE® WINDSHIELD RETAIL PRICING**

Mfg/N	P/N	Mfg/N	P/N	Mfg/N	P/N	Mfg/N	P/N
KIT-Q142	558026	N21919	558041	N76606	558046	N21127A	557492
KIT-Q342	558028	N21920	558042	N21431	558106	N21131A	557493
N21119	558031	N21927	558043	N21133	558110	N21417A	557495
N21917	558039	N21928	558044	N21734	558114	N21428A	557496
N21918	558040	N76605	558045	N21117A	557491	N21440A	557497

# WINDSHIELDS

AUDIO, VIDEO & NAVIGATION



INDIAN & VICTORY

WINDSHIELDS

SEATS & SISSY BARS

LUGGAGE

WHEELS

BRAKES

CHASSIS

SUSPENSION

SHEET METAL

EXHAUST

FUEL & AIR SYSTEMS

ENGINE

PRIMARY DRIVE

TRANSMISSION & FINAL DRIVE

GASKETS

HANDLEBARS & CONTROL

CABLES

FOOT CONTROL

INSTRUMENT & LIGHTING

ELECTRICAL

SECURITY & COVERS

GENERAL ACCESSORIES & DISPLAY

CROSS REFERENCE

## NATIONAL CYCLE® SPARTAN QUICK RELEASE WINDSHIELDS

Made of 4.0mm polycarbonate for impact strength 20x greater than acrylic. Quantum™ hard coating provides unbeatable scratch resistance 30x greater than acrylic. Mounts to the tried-and-true SwitchBlade® Mount Kits. Easy custom fitments with patented slotted tabs that adjust for different width forks. Rubber grommet suspension with compression limiters.

- Three-year manufacturer's warranty against breakage
- Made in USA
- All National Cycle Switchblade Windshield accessories also fit the Spartan Windshields

Note: Mount kits are sold separately.



Mounts to National Cycle's SwitchBlade® Mount Kits!

552816

Shown with 551098 Holdster™ Windshield Bag



552820



552816



**Spartan's unique patented parallel slotted tabs easily adjust for a perfect, customized fit no matter what fork width your bike has.**

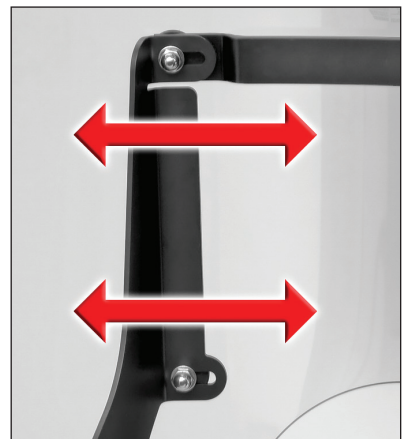

Spartan Windshields are manufactured in the USA from thick, durable hardcoated polycarbonate and are covered by National Cycle's exclusive 3-Year Warranty against breakage!



National Cycle's exclusive Quantum® hardcoating takes motorcycle windshields a quantum leap forward. These are the strongest, most scratch resistant windshields available anywhere. Quantum® is an exclusive product of National Cycle Inc.



**NATIONAL CYCLE SPARTAN® QUICK RELEASE WINDSHIELDS** continued from previous page.

SOFTAIL	Year	16.25" Shield	18.50" Shield	Chrome Lowers	Mount Kit
FXS	11-13	<b>552818</b>	<b>552816</b>		<b>558026</b>
FXST	84-90, 99-12	<b>552818</b>	<b>552816</b>	<b>558045</b>	<b>558026</b>
FXSTC	87-99, 07-10	<b>552818</b>	<b>552816</b>	<b>558045</b>	<b>558026</b>
FXSTB	99-09	<b>552818</b>	<b>552816</b>		<b>558026</b>
FXCW/C	08-11	<b>552818</b>	<b>552816</b>	<b>558045</b>	<b>557842</b>
FXSTD	00-07	<b>552818</b>	<b>552816</b>	<b>558045</b>	<b>558026</b>
<b>DYNA</b>					
FXDB	06-17	<b>552818<sup>3</sup></b>	<b>552816<sup>3</sup></b>	<b>558045<sup>3</sup></b>	<b>557842<sup>3</sup></b>
FXDC	06-14	<b>552818<sup>3</sup></b>	<b>552816<sup>3</sup></b>	<b>558045<sup>3</sup></b>	<b>557842<sup>3</sup></b>
FXD	06-10	<b>552818<sup>3</sup></b>	<b>552816<sup>3</sup></b>	<b>558045<sup>3</sup></b>	<b>557842<sup>3</sup></b>
FXDL	06-09	<b>552818<sup>3</sup></b>	<b>552816<sup>3</sup></b>	<b>558045<sup>3</sup></b>	<b>557842<sup>3</sup></b>
FXDS	94-00	<b>552820<sup>4</sup></b>	<b>552819<sup>4</sup></b>	<b>558045<sup>4</sup></b>	<b>558025<sup>4</sup></b>
FXD/L/X/C	93-05	<b>552820<sup>4</sup></b>	<b>552819<sup>4</sup></b>	<b>558045<sup>4</sup></b>	<b>558025<sup>4</sup></b>
FXDWG	06-08, 10-17	<b>552818<sup>3</sup></b>	<b>552816<sup>3</sup></b>	<b>558045<sup>3</sup></b>	<b>557842<sup>3</sup></b>
FXDWG	93-05	<b>552818<sup>5</sup></b>	<b>552816<sup>5</sup></b>	<b>558045<sup>5</sup></b>	<b>558026<sup>5</sup></b>
<b>FXR</b>					
FXR/S	88-94	<b>552820<sup>4</sup></b>	<b>552819<sup>4</sup></b>	<b>558045<sup>4</sup></b>	<b>558025<sup>4</sup></b>
<b>FX</b>					
FXLR	88-94	<b>552820<sup>4</sup></b>	<b>552819<sup>4</sup></b>	<b>558045<sup>4</sup></b>	<b>558025<sup>4</sup></b>
FXWG	80-85	<b>552818<sup>5</sup></b>	<b>552816<sup>5</sup></b>	<b>558045<sup>5</sup></b>	<b>558026<sup>5</sup></b>
<b>SPORTSTER</b>					
XL1200V	12-16	<b>552820<sup>4</sup></b>	<b>552819<sup>4</sup></b>	<b>558045<sup>4</sup></b>	<b>558025<sup>4</sup></b>
XL1200N/XL883N	07-22	<b>552820<sup>4</sup></b>	<b>552819<sup>4</sup></b>	<b>558045<sup>4</sup></b>	<b>558025<sup>4</sup></b>
XL1200L/XL883L	05-19	<b>552820<sup>4</sup></b>	<b>552819<sup>4</sup></b>	<b>558045<sup>4</sup></b>	<b>558025<sup>4</sup></b>
XL1200C/XL883C	96-17	<b>552820<sup>4</sup></b>	<b>552819<sup>4</sup></b>	<b>558045<sup>4</sup></b>	<b>558025<sup>4</sup></b>
XL1200R/XL883R	02-13	<b>552820<sup>4</sup></b>	<b>552819<sup>4</sup></b>	<b>558045<sup>4</sup></b>	<b>558025<sup>4</sup></b>
XL1200/XL883	04-11	<b>552820<sup>4</sup></b>	<b>552819<sup>4</sup></b>	<b>558045<sup>4</sup></b>	<b>558025<sup>4</sup></b>
XLH1200/XLH883	88-03	<b>552820<sup>4</sup></b>	<b>552819<sup>4</sup></b>	<b>558045<sup>4</sup></b>	<b>558025<sup>4</sup></b>
XL1200S	96-03	<b>552820<sup>4</sup></b>	<b>552819<sup>4</sup></b>	<b>558045<sup>4</sup></b>	<b>558025<sup>4</sup></b>

<sup>1</sup> With no H-D® light bar installed      <sup>4</sup> With 39mm fork tubes  
<sup>2</sup> With H-D® light bar installed      <sup>5</sup> With 41mm fork tubes  
<sup>3</sup> With 49mm fork tubes

**NATIONAL CYCLE SPARTAN® WINDSHIELD RETAIL PRICING**

Mfg/N	P/N	Mfg/N	P/N	Mfg/N	P/N
N21200	<b>552815</b>	KIT-Q344-001	<b>553964</b>	KIT-Q342	<b>558028</b>
N21201	<b>552816</b>	KIT-Q143	<b>557842</b>	KIT-Q343	<b>558029</b>
N21301	<b>552818</b>	KIT-Q141	<b>558025</b>	N76605	<b>558045</b>
N21202	<b>552819</b>	KIT-Q142	<b>558026</b>	N76606	<b>558046</b>
N21302	<b>552820</b>	KIT-Q341	<b>558027</b>		

**SPARTAN WINDSHIELD DIMENSIONS**

P/N	Cutout To Top	Overall Width	P/N	Cutout To Top	Overall Width
Spartan® Low Touring Clear			Spartan® Tall Touring Clear		
	<b>552818</b>	16.25" (41.3cm)		<b>552815</b>	18.50" (47.0cm)
<b>552820</b>	16.25" (41.3cm)	18.00" (45.7cm)	<b>552816</b>	18.50" (47.0cm)	18.60" (45.7cm)
			<b>552819</b>	18.50" (47.0cm)	18.20" (45.7cm)

Shield Wash and Rainzip **ON PAGE 248**

- AUDIO, VIDEO & NAVIGATION
- INDIAN & VICTORY
- WINDSHIELDS
- SEATS & SISSY BARS
- LUGGAGE
- WHEELS
- BRAKES
- CHASSIS
- SUSPENSION
- SHEET METAL
- EXHAUST
- FUEL & AIR SYSTEMS
- ENGINE
- PRIMARY DRIVE
- TRANSMISSION & FINAL DRIVE
- GASKETS
- HANDLEBARS & CONTROL
- CABLES
- FOOT CONTROL
- INSTRUMENT & LIGHTING
- ELECTRICAL
- SECURITY & COVERS
- GENERAL ACCESSORIES & DISPLAY
- CROSS REFERENCE

AUDIO,  
VIDEO &  
NAVIGATION



INDIAN  
& VICTORY

## NATIONAL CYCLE® WAVE QR FAIRINGS AND MOUNTING KITS Innovative quick-release fairings...more than just a windshield!

WINDSHIELDS

The stylish Wave QR Fairing will give your motorcycle one big attitude. It fits the front end like a glove and features chrome quick release brackets with rake adjustability. The fairing is completely assembled and ready to mount to National Cycle's Quick Release Mount Kit.

- Polycarbonate with FMR hardcoat
- Chrome quick release hardware with rake adjustability
- The highly regarded Quick Release Mount Kit is the same as used for SwitchBlade® and Spartan® Windshields
- Mount Kit sold separately
- Three-year manufacturer's warranty against breakage
- Made in USA
- XL model in light tint (screen size requires light tint for DOT approval), all other models in dark tint

SEATS &  
SISSY BARS

LUGGAGE

WHEELS

BRAKES

CHASSIS

SUSPENSION

SHEET METAL

EXHAUST

FUEL & AIR  
SYSTEMS

ENGINE

PRIMARY  
DRIVE

TRANSMISSION  
& FINAL DRIVE

GASKETS

HANDLEBARS  
& CONTROL

CABLES

FOOT  
CONTROL

INSTRUMENT  
& LIGHTING

ELECTRICAL

SECURITY  
& COVERS

GENERAL  
ACCESSORIES  
& DISPLAY

CROSS  
REFERENCE

SOFTAIL	Year	Color	Fairings	Mount Kits
FLSS	16-17	Dark Tint	<b>551603</b>	<b>558027<sup>2</sup></b>
FLS	12-17	Dark Tint	<b>551603<sup>2</sup></b>	<b>558027<sup>2</sup></b>
FLSTFBS	16-17	Dark Tint	<b>551603</b>	<b>558027<sup>2</sup></b>
FLSTN	05-17	Dark Tint	<b>551603<sup>2</sup></b>	<b>558027<sup>2</sup></b>
FLSTC	87-17	Dark Tint	<b>551603<sup>2</sup></b>	<b>558027<sup>2</sup></b>
FLST	86-90	Dark Tint	<b>551603<sup>2</sup></b>	<b>558027<sup>2</sup></b>
FLSTF/B	07-17	Dark Tint	<b>551603<sup>2</sup></b>	<b>558027<sup>2</sup></b>
FLSTF	90-06	Dark Tint	<b>551603<sup>2</sup></b>	<b>558027<sup>2</sup></b>

### DYNA

FXDB	06-17	Dark Tint	<b>551601</b>	<b>557842</b>
FXDC	07-14	Dark Tint	<b>551601</b>	<b>557842</b>
FXDL	06-09	Dark Tint	<b>551601</b>	<b>557842</b>
FXD/L/C	93-05	Light Tint	<b>551600<sup>1</sup></b>	<b>558025<sup>1</sup></b>

### SPORTSTER

XL1200V	12-16	Light Tint	<b>551600</b>	<b>558025</b>
XL1200/883L	05-14	Light Tint	<b>551600</b>	<b>558025</b>
XL1200/883C	96-14	Light Tint	<b>551600</b>	<b>558025</b>
XL1200N	07-12	Light Tint	<b>551600</b>	<b>558025</b>
XL1200/883	96-10	Light Tint	<b>551600</b>	<b>558025</b>
XL883N	09-21	Light Tint	<b>551600</b>	<b>558025</b>
XL883R	05-07	Light Tint	<b>551600</b>	<b>558025</b>

<sup>1</sup> Single (speed) gauge only

<sup>2</sup> Will not work with O.E.M. or aftermarket spotlight bars

## NATIONAL CYCLE® WAVE QR FAIRING/MOUNT KIT RETAIL PRICING

Mfg/N	P/N	Mfg/N	P/N
N21610	<b>551600</b>	KIT-Q141	<b>558025</b>
N21601	<b>551601</b>	KIT-Q341	<b>558027</b>
N21603	<b>551603</b>	KIT-Q343	<b>558029</b>
KIT-Q143	<b>557842</b>		

## WAVE QR WINDSHIELD DIMENSIONS

P/N	Cutout To Top	Overall Width
<b>Wave QR® Fairing</b>		
<b>95% Dark Tint</b>		
<b>551601</b>	10.50" (26.7cm)	17.00" (43.2cm)
<b>551603</b>	12.50" (31.8cm)	18.25" (46.3cm)
<b>26% Light Grey Tint</b>		
<b>551600</b>	13.00" (33.0cm)	16.00" (40.6cm)

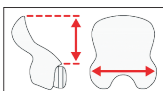

Wave QR Fairings are measured from the headlight cutout in a vertical line level to the top of the shield in the fully raked forward position. Width is measured in a straight line across the back of the shield at its widest point.

551600



551601



551603



Wave QR Fairings are manufactured in the USA from thick, durable hardcoated polycarbonate and are covered by National Cycle's exclusive 3-Year Warranty against breakage!

Shield Wash and Rainzip **ON PAGE 248**



**NATIONAL CYCLE® HEAVY DUTY™ WINDSHIELDS**

The famous Heavy Duty™ line of superior quality windshields feature hardcoated Quantum® hardcoated polycarbonate construction, polished chromed steel outer hardware and black epoxy coated inner hardware. Available in two frame widths and six styles to suit any rider and any cruiser motorcycle. Classic style with adjustable center window. Chrome plated Heavy Duty™ Mount Kits are bike-specific and are sold separately.

- Made in USA



**Wide Frame Heavy Duty**

**Narrow Frame Heavy Duty**

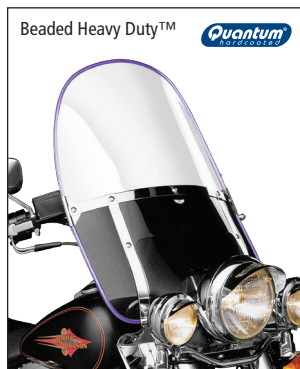
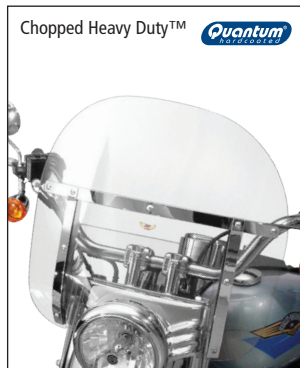
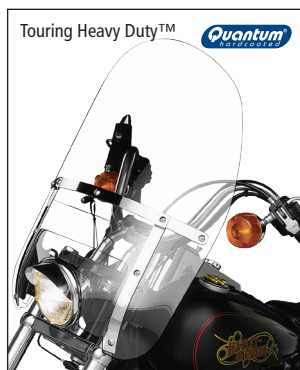

**Wide Frame or Narrow Frame?**

Heavy Duty™ Windshields are in Wide and Narrow Frame to provide you a selection of sizes and looks for your motorcycle.

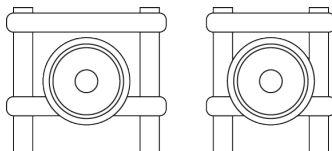

**Wide Frame Heavy Duty Windshields** are intended for bikes with wide spacing between the fork tubes measured center-to-center. Mount Kits for wide frame bikes will only accept Wide Frame Heavy Duty Windshields.

**Narrow Frame Heavy Duty Windshields** look best on bikes with narrow spacing between the fork tubes. In some cases - and with the appropriate Mount Kit - a Wide Frame Heavy Duty Windshield can be mounted on a bike with a narrow frame fork tube spacing.



All Heavy Duty Windshields are manufactured in the USA from thick, durable hardcoated polycarbonate and are covered by National Cycle's exclusive 3-Year Warranty against breakage!



National Cycle's exclusive Quantum® hardcoating takes motorcycle windshields a quantum leap forward. These are the strongest, most scratch resistant windshields available anywhere. Quantum® is an exclusive product of National Cycle Inc.

**Touring Heavy Duty™ (Wide Frame)**

- Tall screen with wide proportions, excellent wind protection
- Great choice for taller riders, and a top seller
- Classic looks and high-luster chrome outside hardware

**Chopped Heavy Duty™ (Wide Frame)**

- Low-profile screen with wide proportions, great wind protection
- Preferred by riders who want to see over the screen
- Excellent choice for shorter riders and low saddle heights

**Beaded Heavy Duty™ (Wide Frame)**

- Authentic, classic three-piece construction with beaded trim
- Choice of clear or black lowers
- Vintage looks with modern materials and performance

**Custom Heavy Duty™ (Narrow Frame)**

- Tall screen with slim proportions, excellent wind protection
- One of the most popular windshields on the market
- Great choice for touring on almost any cruiser

**Low Boy Heavy Duty™ (Narrow Frame)**

- Great choice for shorter riders and low saddle heights
- Cut-down version of the Custom Heavy Duty
- Classic looks and high-luster chrome outside hardware

**Ranger Heavy Duty™ (Narrow Frame)**

- Takes the slim and compact profile to the limit
- The perfect solution for riders who want just a small shield
- Great for low-profile, performance-styled cruiser

AUDIO, VIDEO & NAVIGATION

INDIAN & VICTORY

WINDSHIELDS

SEATS & SISSY BARS

LUGGAGE

WHEELS

BRAKES

CHASSIS

SUSPENSION

SHEET METAL

EXHAUST

FUEL & AIR SYSTEMS

ENGINE

PRIMARY DRIVE

TRANSMISSION & FINAL DRIVE

GASKETS

HANDLEBARS & CONTROL

CABLES

FOOT CONTROL

INSTRUMENT & LIGHTING

ELECTRICAL

SECURITY & COVERS

GENERAL ACCESSORIES & DISPLAY

CROSS REFERENCE

## WIDE FRAME WINDSHIELD MEASUREMENTS

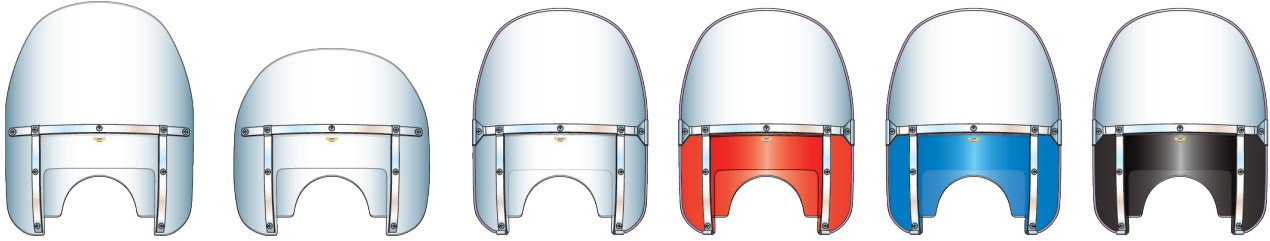

### Touring Heavy Duty

Cutout to Top  
20.00 - 21.50"  
(50.8 - 54.6cm)  
Overall Width  
21.50" (54.6cm)

### Chopped Heavy Duty

Cutout to Top  
14.25 - 15.75"  
(36.2 - 40.0cm)  
Overall Width  
21.50" (54.6cm)

### Beaded Heavy Duty

Cutout to Top  
19.50 - 21.25"  
(49.5 - 54.0cm)  
Overall Width  
22.50" (57.0cm)

## NARROW FRAME WINDSHIELD MEASUREMENTS

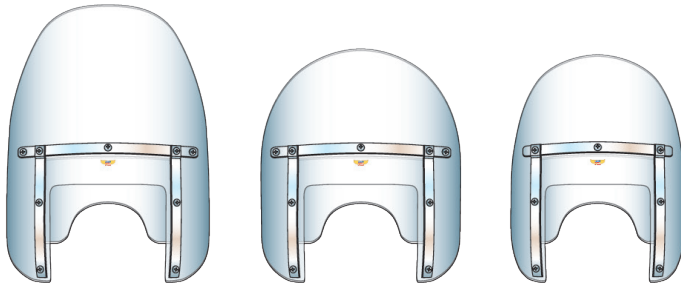

### Custom Heavy Duty

Cutout to Top  
19.00 - 21.00"  
(48.2 - 53.3cm)  
Overall Width  
19.00" (48.3cm)

### Low Boy Heavy Duty

Cutout to Top  
14.25 - 16.00"  
(36.2 - 40.6cm)  
Overall Width  
18.75 in. (47.6cm)

### Ranger Heavy Duty

Cutout to Top  
13.75 - 16.25"  
(34.9 - 41.3cm)  
Overall Width  
16.50" (42.0cm)



Heavy Duty Windshields are measured from the top of the headlight cutout to the top of the screen and horizontally across the back at the widest point.

### How to Select the Correct Heavy Duty Windshield and Mount Kit for Your Bike

1. Determine your motorcycle's make, model and year.
2. Choose the Heavy Duty™ Mount Kit for your bike (see application chart on page 239).
3. Determine what style windshield best fits you.
  - Consider your height and saddle position.
  - Determine your riding habits: Daily commutes? Long trips? Weekend rides?
  - Consider the width of your bike's forks and what would look best on your bike.
4. Pick your Heavy Duty™ windshield style and model.

## HEAVY DUTY WINDSHIELD MOUNT KITS



Heavy Duty™ Mount Kits for FX, XL models



Heavy Duty™ Mount Kits for FLS models



553090

553096

### CHM/CHK/CHO Series Mount Kits

- Unique hinged clamp design for quick and easy installation or removal
- High-luster chrome finish

### CHN/CHQ Series Mount Kits

- are made for bikes with side-mount fixtures
- High-luster chrome finish

NATIONAL CYCLE WINDSHIELDS

NATIONAL CYCLE® HEAVY DUTY WINDSHIELDS MOUNT KITS AND CHROME LOWERS

TOURING	Year	Narrow Frame Mount Kits	Wide Frame Mount Kits
FLHS	77-93		553096 <sup>2,4</sup>
FL	60-84		553096 <sup>4</sup>
<b>SOFTAIL</b>			
FLSS	16-17		553094 <sup>5</sup>
FLS	12-17		553094 <sup>5</sup>
FLSTC	87-17		553094 <sup>5</sup>
FLSTN/H	94-96		553094 <sup>5</sup>
FLSTN	1993		553094 <sup>5</sup>
FLST	86-90		553094 <sup>5</sup>
FLSTF/B	90-17		553094 <sup>5</sup>
FXST	84-90, 99-12	553093	553095
FXSTC	87-99, 07-10	553093	553095
FXSTB	99-09	553093	553095
FXSTD	00-07	553093	553095
<b>DYNA</b>			
FXD/L/X/C	93-05	553090 <sup>6</sup>	
FXDS	94-99	553090 <sup>6</sup>	
FXDWG	93-05	553093 <sup>7</sup>	553095 <sup>7</sup>
<b>FXR</b>			
FXR/S	82-94	553090 <sup>6</sup>	
<b>FX</b>			
FXLR	87-94	553090 <sup>6</sup>	
FXWG	80-85	553093 <sup>7</sup>	553095 <sup>7</sup>
FXS/B	77-85	553090 <sup>6</sup>	
FX/FXE/FXEF	70-85	553090 <sup>6</sup>	
<b>SPORTSTER</b>			
XL1200N/XL883N	07-22	553090 <sup>6</sup>	
XL1200V	12-16	553090 <sup>6</sup>	
XL1200R/XL883R	02-13	553090 <sup>6</sup>	
XL1200L	06-11	553090 <sup>6</sup>	
XL1200/XL883	04-10	553090 <sup>6</sup>	
XL1200C/XL883C	96-10	553090 <sup>6</sup>	
XL1200S	96-03	553090 <sup>6</sup>	
XLH1200/XLH883	88-03	553090 <sup>6</sup>	
XL883L	05-10	553090 <sup>6</sup>	
XL1100/XL883	86-87	553090 <sup>6</sup>	
XLX	83-85	553090 <sup>6</sup>	
XLS	79-85	553090 <sup>6</sup>	
XL/XLH/XLCH	72-85	553808 <sup>6</sup>	
XR1000	83-84	553090 <sup>6</sup>	

<sup>1</sup> Fits Wide Frame Heavy Duty windshields only

<sup>2</sup> Use Touring Heavy Duty 553814 (complete with FLHS window); also requires use of original equipment windshield brackets 57953-92T or equivalent

<sup>3</sup> Substitute 553814 Touring Heavy Duty or 552271 Chopped Heavy Duty; no Beaded Heavy Duty fitment for this model

<sup>4</sup> With or without H-D light bar installed

<sup>5</sup> Without H-D light bar installed

<sup>6</sup> With 39mm fork tubes

<sup>7</sup> With 41mm fork tubes

NATIONAL CYCLE® HEAVY DUTY™ WINDSHIELDS

Touring Wide Frame

Mfg/N	P/N
N2210	553813
N2211	553814

Chopped Wide Frame

Mfg/N	P/N
N2270	552270
N2271	552271

Beaded Wide Frame

Mfg/N	P/N
N2230	552230
N2231	552231
N2232	552232
N2233	552233
N2234	553506
N2235	553507
N2236	553508

Custom Narrow Frame

Mfg/N	P/N
N2220	553809

Low Boy Narrow Frame

Mfg/N	P/N
N2221	552436

Narrow Frame Mount Kits

Mfg/N	P/N
KIT-CHK	553090
KIT-HB	553808
KIT-CHM	553093

Wide Frame Mount Kit

Mfg/N	P/N
KIT-CHN	553094
KIT-CHO	553095
KIT-CHQ	553096

Ranger Narrow Frame

Mfg/N	P/N
N2290	553816

AUDIO, VIDEO & NAVIGATION

INDIAN & VICTORY

WINDSHIELDS

SEATS & SISSY BARS

LUGGAGE

WHEELS

BRAKES

CHASSIS

SUSPENSION

SHEET METAL

EXHAUST

FUEL & AIR SYSTEMS

ENGINE

PRIMARY DRIVE

TRANSMISSION & FINAL DRIVE

GASKETS

HANDLEBARS & CONTROL

CABLES

FOOT CONTROL

INSTRUMENT & LIGHTING

ELECTRICAL

SECURITY & COVERS

GENERAL ACCESSORIES & DISPLAY

CROSS REFERENCE



AUDIO, VIDEO & NAVIGATION



**national cycle**

INDIAN & VICTORY

WINDSHIELDS

SEATS & SISSY BARS

LUGGAGE

WHEELS

BRAKES

CHASSIS

SUSPENSION

SHEET METAL

EXHAUST

FUEL & AIR SYSTEMS

ENGINE

PRIMARY DRIVE

TRANSMISSION & FINAL DRIVE

GASKETS

HANDLEBARS & CONTROL

CABLES

FOOT CONTROL

INSTRUMENT & LIGHTING

ELECTRICAL

SECURITY & COVERS

GENERAL ACCESSORIES & DISPLAY

CROSS REFERENCE



552911



552914



552913



552912

### NATIONAL CYCLE® VINTAGE-STYLE BEADED WINDSHIELD

Attention all vintage restoration experts, National Cycle® Vintage-Style Beaded Windshields are now available for restoring your 36-47 Knucklehead or 1948 Panhead. These windshields are modeled directly from actual vintage windshields that National Cycle manufactured beginning in 1937. If your original windshield is old or cracked, replace it with an exact reproduction made by the same original manufacturer.

- Available in Clear, Black, Blue and Red
- Comes complete with all mounting hardware exactly like the originals
- Made from virtually unbreakable polycarbonate with an additional Quantum® hardcoating on the upper section for the best scratch resistance
- Beaded edge and steel ring are retained for an authentic, period correct appearance
- Three-year manufacturer's warranty against breakage
- Made in USA

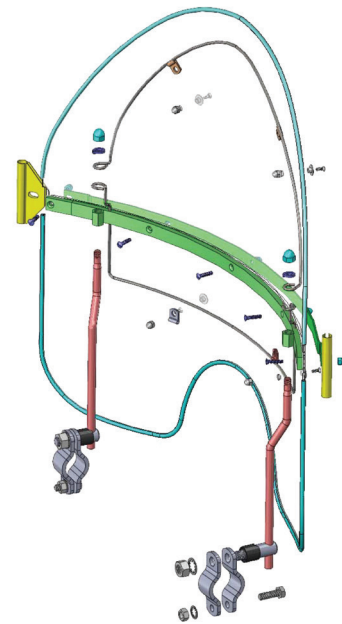

HARLEY-DAVIDSON	Year	Color	P/N
EL, FL	1936-48	Clear	<b>552911</b>
EL, FL	1936-48	Black	<b>552914</b>
EL, FL	1936-48	Blue	<b>552913</b>
EL, FL	1936-48	Red	<b>552912</b>



All Vintage-Style Beaded Windshields are manufactured in the USA from thick, durable hardcoated polycarbonate and are covered by National Cycle's exclusive 3-Year Warranty against breakage!



National Cycle's exclusive Quantum® hardcoating takes motorcycle windshields a quantum leap forward. These are the strongest, most scratch resistant windshields available anywhere. Quantum® is an exclusive product of National Cycle Inc.



**NATIONAL CYCLE®  
UNIVERSAL MOUNT FLYSCREEN® WINDSHIELDS**

The Flyscreen® is a stylish item for custom cruisers, muscle bikes and performance machines. The clean, minimal appearance and chrome trim plate will enhance the look of your bike. The quality Linking Arm fork mount system with the counter sunk screws offers a custom fit for most motorcycles with open front forks. The popular and best-selling Flyscreen is a timeless classic.

- Chrome-plated hardware
- Chrome fork mounts and flush-fit countersunk hex bolts included
- 9" height from headlight cutout to top of screen
- Made in USA
- Various fork clamp sizes are available. Verify your fork tube outside diameter before ordering



Flyscreen Dark Tint Windshields are manufactured in the USA from thick, durable hardcoated polycarbonate and are covered by National Cycle's exclusive 3-Year Warranty against breakage!



- AUDIO, VIDEO & NAVIGATION
- INDIAN & VICTORY
- WINDSHIELDS**
- SEATS & SISSY BARS
- LUGGAGE
- WHEELS
- BRAKES
- CHASSIS
- SUSPENSION
- SHEET METAL

**Light Tint/Chrome Mounts**



35-43mm OD Fork Tubes

Color	P/N
Chrome/Light Tint	<b>552530</b>
Chrome/Dark Tint	<b>552531</b>
Black/Light Tint	<b>552989</b>
Black/Dark Tint	<b>552990</b>

**Dark Tint/Chrome Mounts**



44-51mm OD Fork Tubes

Color	Type	P/N
Chrome/Light Tint	Curved	<b>552839</b>
Black/Light Tint	Straight	<b>552836</b>
Black/Light Tint	Curved	<b>552840</b>
Chrome/Dark Tint	Straight	<b>552837</b>
Chrome/Dark Tint	Curved	<b>552841</b>
Black/Dark Tint	Straight	<b>552838</b>
Black/Darksmoke	Curve	<b>552842</b>

**Light Tint/Black Mounts**



44-56mm OD Fork Tubes

Color	P/N
Chrome/Light Tint	<b>552534</b>
Chrome/Dark Tint	<b>552535</b>
Black/Dark Tint	<b>552994</b>

**Dark Tint/Black Mounts**



Indian & Victory **ON PAGE 101**

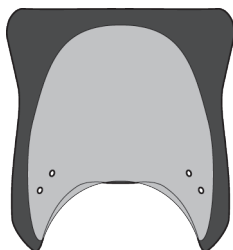

**Flyscreen**  
Height: 8.50" (21.6cm)  
Width: 9.25" (23.5cm)

**Mohawk**  
Height: 9.25" (23.5cm)  
Width: 11.75" (29.8cm)



Flyscreen Windshields are measured from the top of the headlight cutout to the top of the screen and horizontally across the back at the widest point.

Shield Wash and Rainzip **ON PAGE 248**

- EXHAUST
- FUEL & AIR SYSTEMS
- ENGINE
- PRIMARY DRIVE
- TRANSMISSION & FINAL DRIVE
- GASKETS
- HANDLEBARS & CONTROL
- CABLES
- FOOT CONTROL
- INSTRUMENT & LIGHTING
- ELECTRICAL
- SECURITY & COVERS
- GENERAL ACCESSORIES & DISPLAY
- CROSS REFERENCE

- AUDIO, VIDEO & NAVIGATION
- INDIAN & VICTORY
- WINDSHIELDS
- SEATS & SISSY BARS
- LUGGAGE
- WHEELS
- BRAKES
- CHASSIS



## NATIONAL CYCLE® UNIVERSAL MOUNT MOHAWK WINDSHIELDS

Continuing the minimalist, sporty tradition of the Flyscreen®, the Mohawk® features a taller and wider size with a special "V" profile for added wind management. Made from 4.5mm hardcoated polycarbonate for superior scratch resistance and impact strength.

- Part numbers include the correct size mounting hardware for your model bike
- Easy to install and highly adjustable for the look you want
- Three-year manufacturer's warranty against breakage
- Made in USA



Mohawk Windshields are manufactured in the USA from thick, durable hardcoated polycarbonate and are covered by National Cycle's exclusive 3-Year Warranty against breakage!

- SUSPENSION
- SHEET METAL
- EXHAUST
- FUEL & AIR SYSTEMS
- ENGINE
- PRIMARY DRIVE
- TRANSMISSION & FINAL DRIVE
- GASKETS

### Dark Tint/Chrome Mounts



Application	Type	Finish	P/N
Fits up to 43mm OD Fork Tubes	Short	Chrome	<b>552999</b>
Fits up to 43mm OD Fork Tubes	Short	Black	<b>553002</b>
Fits 44-51mm OD Fork Tubes	Short	Chrome	<b>553009</b>
Fits 44-51mm OD Fork Tubes	Short	Black	<b>553043</b>
Fits 52-56mm OD Fork Tubes	Short	Chrome	<b>553005</b>

### Dark Tint/Black Mounts



Application	Type	Finish	P/N
Fits 52-56mm OD Fork Tubes	Short	Black	<b>553006</b>
Fits 52-56mm OD Fork Tubes	Long	Chrome	<b>553007</b>
Fits 52-56mm OD Fork Tubes	Long	Black	<b>553008</b>
Headlight Mount	Straight	Black	<b>553029</b>

- HANDLEBARS & CONTROL
- CABLES
- FOOT CONTROL
- INSTRUMENT & LIGHTING
- ELECTRICAL
- SECURITY & COVERS
- GENERAL ACCESSORIES & DISPLAY
- CROSS REFERENCE

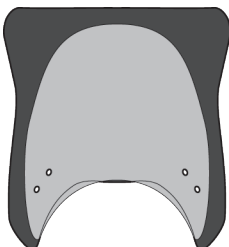

**Flyscreen**  
Height: 8.50" (21.6cm)  
Width: 9.25" (23.5cm)

**Mohawk**  
Height: 9.25" (23.5cm)  
Width: 11.75" (29.8cm)



Flyscreen Windshields are measured from the top of the headlight cutout to the top of the screen and horizontally across the back at the widest point.

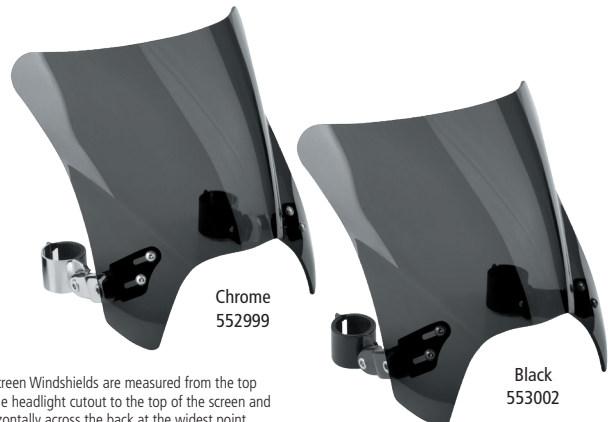



**NATIONAL CYCLE® STREET SHIELD EX**

No-Hole Ballsocket™ 4-point mounting system.

- Extra-heavy gauge, tinted acrylic
- Center screen height of 18-1/2" for great protection
- QuickSet™ hardware kit included for tool-free, quick release
- Made in USA
- For motorcycles with non-tubular handlebars, order BAG#47A and BAG#53.



Application	Color	Mfg/N	P/N
For use with 7/8" handlebars	Light Tint	N2567-01	<b>552567</b>
For use with 1" handlebars	Light Tint	N2568-01	<b>552568</b>



*Replacement Hardware for Street Shield EX*

Description	Mfg/N	P/N
Complete Kit, 1" bars	KIT-ATZ	<b>553060</b>
1-1/4" Quickset™ Clamps	BAG#78	<b>553078</b>

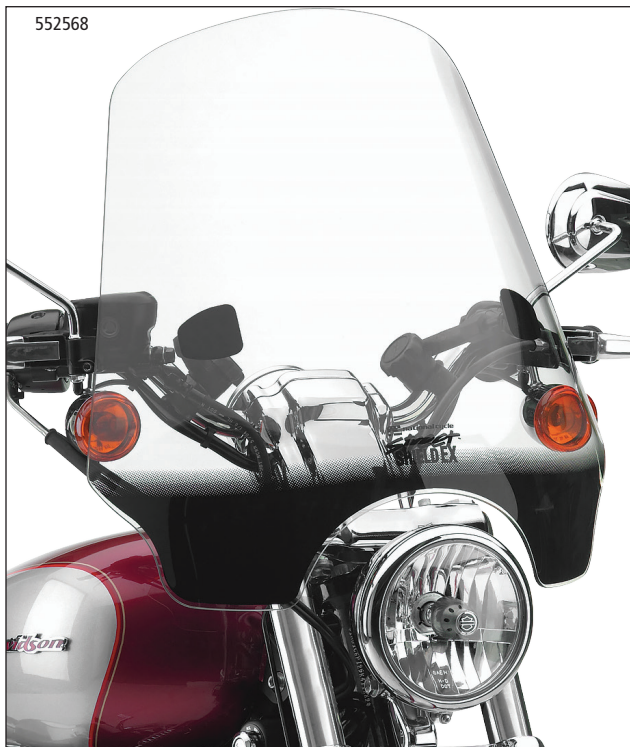

Simply turn the four QuickSet™ knobs and the windshield is off in seconds while the unobtrusive mounts stay attached to the handlebars and upper fork tubes.

**Street Shield EX**

Height: 18.50" (46.9cm)  
Width: 19.50" (49.5cm)



Street Shield EX Windshields are measured from the top of the headlight cutout to the top of the screen and horizontally across the back at the widest point.

**Street Shield EX fits a long legacy of models back to 1957.**



- AUDIO, VIDEO & NAVIGATION
- INDIAN & VICTORY
- WINDSHIELDS**
- SEATS & SISSY BARS
- LUGGAGE
- WHEELS
- BRAKES
- CHASSIS
- SUSPENSION
- SHEET METAL
- EXHAUST
- FUEL & AIR SYSTEMS
- ENGINE
- PRIMARY DRIVE
- TRANSMISSION & FINAL DRIVE
- GASKETS
- HANDLEBARS & CONTROL
- CABLES
- FOOT CONTROL
- INSTRUMENT & LIGHTING
- ELECTRICAL
- SECURITY & COVERS
- GENERAL ACCESSORIES & DISPLAY
- CROSS REFERENCE

AUDIO, VIDEO & NAVIGATION

INDIAN & VICTORY

WINDSHIELDS

SEATS & SISSY BARS

LUGGAGE

WHEELS

BRAKES

CHASSIS

SUSPENSION

SHEET METAL

EXHAUST

FUEL & AIR SYSTEMS

ENGINE

PRIMARY DRIVE

TRANSMISSION & FINAL DRIVE

GASKETS

HANDLEBARS & CONTROL

CABLES

FOOT CONTROL

INSTRUMENT & LIGHTING

ELECTRICAL

SECURITY & COVERS

GENERAL ACCESSORIES & DISPLAY

CROSS REFERENCE



553568

Quantum  
hardcoated



## NATIONAL CYCLE® UNIVERSAL MOUNT STREET SHIELD

Clear polycarbonate.

- 4-point QuickSet™ or U-Clamp mounting system
- 17" height, an excellent mid-size screen
- Three-year manufacturer's warranty
- Made in USA

**Note: BAG#047A and BAG#053 needed for non-tubular bars. BAG#054 and BAG#062 needed for mirror mount.**



Street Shields are manufactured in the USA from thick, durable hardcoated polycarbonate and are covered by National Cycle's exclusive 3-Year Warranty against breakage!



National Cycle's exclusive Quantum® hardcoating takes motorcycle windshields a quantum leap forward. These are the strongest, most scratch resistant windshields available anywhere. Quantum® is an exclusive product of National Cycle Inc.

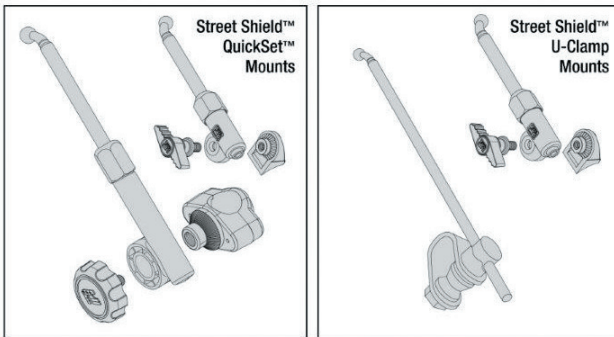

### STREET SHIELD RETAIL PRICES

Application	Color	Mfg/N	P/N
QuickSet™ 7/8" Handlebars	Tint	N25011	<b>553581</b>
QuickSet™ 1" Handlebars	Clear	N25012	<b>553568</b>
QuickSet™ 1" Handlebars	Tint	N25013	<b>553582</b>
QuickSet™ 1-1/4" Handlebars	Tint	N25015	<b>553583</b>
U-Clamp Mount 7/8" and 1" handlebars	Clear	N25000	<b>553565</b>
U-Clamp Mount 7/8" and 1" handlebars	Tint	N25001	<b>553580</b>



553582

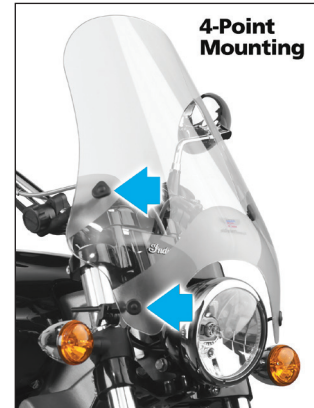

**4-Point Mounting**

## Street Shield

Height: 17.00" (43.2cm)  
Width: 16.50" (42.0cm)



Street Shield Windshields are measured from the top of the headlight cutout to the top of the screen and horizontally across the back at the widest point.



553588

### Replacement Hardware for Street Shield

Description	Mfg/N	P/N
Lower Mount without Rods	BAG#1145	<b>553588</b>



**NATIONAL CYCLE®  
UNIVERSAL MOUNT DEFLECTOR SCREEN**

Features QuickSet™ hardware with Rake Adjust™.

- Adjust or remove in seconds without tools
- D.O.T. approved acrylic plastic
- Three-year manufacturer's warranty
- Made in USA
- For motorcycles with non-tubular handlebars, order BAG#47A



Deflector Screens are manufactured in the USA from thick, durable hardcoated polycarbonate and are covered by National Cycle's exclusive 3-Year Warranty against breakage!



National Cycle's exclusive Quantum® hardcoating takes motorcycle windshields a quantum leap forward. These are the strongest, most scratch resistant windshields available anywhere. Quantum® is an exclusive product of National Cycle Inc.

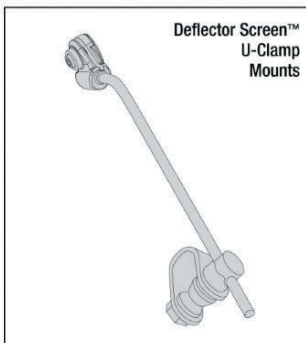
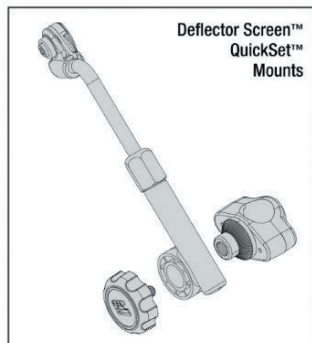

**DEFLECTOR SCREEN RETAIL PRICES**

Application	Color	Mfg/N	P/N
QuickSet™ 7/8" Handlebars	Clear	N25040	<b>553593</b>
QuickSet™ 7/8" Handlebars	Tint	N25041	<b>553585</b>
QuickSet™ 1" Handlebars	Clear	N25042	<b>553594</b>
QuickSet™ 1" Handlebars	Tint	N25043	<b>553586</b>
QuickSet™ 1-1/4" Handlebars	Clear	N25044	<b>553595</b>
QuickSet™ 1-1/4" Handlebars	Tint	N25045	<b>553587</b>
U-Clamp Mount for 7/8" and 1" Handlebars	Clear	N25030	<b>553900</b>
U-Clamp Mount for 7/8" and 1" Handlebars	Tint	N25031	<b>553584</b>

*Replacement Hardware for Deflector Screen*

Description	Mfg/N	P/N
Lower Mount without Rods	BAG#1145	<b>553588</b>



**Deflector Screen**  
Height: 15.50" (39.3cm)  
Width: 15.00" (38.1cm)



Deflector Screens are measured from the top of the headlight cutout to the top of the screen and horizontally across the back at the widest point.



Shield Wash and Rainzip **ON PAGE 248**

- AUDIO, VIDEO & NAVIGATION
- INDIAN & VICTORY
- WINDSHIELDS**
- SEATS & Sissy BARS
- LUGGAGE
- WHEELS
- BRAKES
- CHASSIS
- SUSPENSION
- SHEET METAL
- EXHAUST
- FUEL & AIR SYSTEMS
- ENGINE
- PRIMARY DRIVE
- TRANSMISSION & FINAL DRIVE
- GASKETS
- HANDLEBARS & CONTROL
- CABLES
- FOOT CONTROL
- INSTRUMENT & LIGHTING
- ELECTRICAL
- SECURITY & COVERS
- GENERAL ACCESSORIES & DISPLAY
- CROSS REFERENCE

- AUDIO, VIDEO & NAVIGATION
- INDIAN & VICTORY
- WINDSHIELDS
- SEATS & SISSY BARS
- LUGGAGE
- WHEELS
- BRAKES
- CHASSIS
- SUSPENSION
- SHEET METAL
- EXHAUST
- FUEL & AIR SYSTEMS
- ENGINE
- PRIMARY DRIVE
- TRANSMISSION & FINAL DRIVE
- GASKETS
- HANDLEBARS & CONTROL
- CABLES
- FOOT CONTROL
- INSTRUMENT & LIGHTING
- ELECTRICAL
- SECURITY & COVERS
- GENERAL ACCESSORIES & DISPLAY
- CROSS REFERENCE

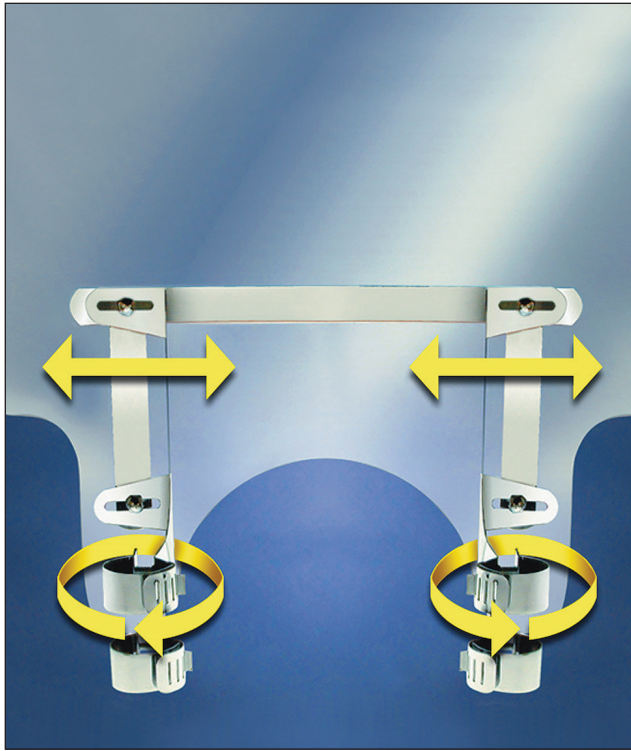

**Variable Width Brackets  
with Adjustable Diameter Fork Clamps  
All Mounting hardware included!**

### NATIONAL CYCLE® DAKOTA 3.0™ WINDSHIELDS

- Clear, economical 3.0mm high-impact acrylic plastic.
- Triple chrome-plated hardware included with windshield
- Great wind protection at a budget price
- Quick and simple installation
- Made in USA



	SOFTAIL	Year	Height	Mfg/N	P/N
	FXST	84-05	17.5"	NC125A	<b>552571</b>
	FXST	84-05	20.5"	N2310	<b>552573</b>
	FXST	84-05	17.5"	NC125B	<b>552572<sup>1</sup></b>
	FXST	84-05	20.5"	N2320	<b>552574<sup>1</sup></b>
	<b>DYNA</b>				
	FXDS	94-00	17.5"	NC125A	<b>552571</b>
	FXDS	94-00	20.5"	N2310	<b>552573</b>
	FXDS	94-00	17.5"	NC125B	<b>552572<sup>1</sup></b>
	FXDS	94-00	20.5"	N2320	<b>552574<sup>1</sup></b>
	<b>FXR</b>				
	FXR/FXRS	82-94	17.5"	NC125A	<b>552571</b>
	FXR/FXRS	82-94	20.5"	N2310	<b>552573</b>
	<b>SPORTSTER</b>				
	XL883	11-13	17.5"	NC125B	<b>552572<sup>1</sup></b>
	XL883	11-13	20.5"	N2320	<b>552574<sup>1</sup></b>
	XLC/XLS	96-10	17.5"	NC125A	<b>552571</b>
	XLC/XLS	96-10	20.5"	N2310	<b>552573</b>
	XLC/XLS	96-10	17.5"	NC125B	<b>552572<sup>1</sup></b>
	XLC/XLS	96-10	20.5"	N2320	<b>552574<sup>1</sup></b>
	XLH	87-11	17.5"	NC125A	<b>552571</b>
	XLH	87-11	20.5"	N2310	<b>552573</b>
	XLH	87-10	17.5"	NC125B	<b>552572<sup>1</sup></b>
	XLH	87-10	20.5"	N2320	<b>552574<sup>1</sup></b>
	XLN	07-19	17.5"	NC125A	<b>552571</b>
	XLN	07-19	20.5"	N2310	<b>552573</b>
	XLN	07-19	17.5"	NC125B	<b>552572<sup>1</sup></b>
	XLN	07-19	20.5"	N2320	<b>552574<sup>1</sup></b>
	XLR	04-08	17.5"	NC125A	<b>552571</b>
	XLR	04-08	20.5"	N2310	<b>552573</b>
	XLR	04-08	17.5"	NC125B	<b>552572<sup>1</sup></b>
	XLR	04-08	20.5"	N2320	<b>552574<sup>1</sup></b>
	XLS	79-85	17.5"	NC125A	<b>552571</b>
	XLS	79-85	20.5"	N2310	<b>552573</b>
	XLX	83-85	17.5"	NC125A	<b>552571</b>
	XLX	83-85	20.5"	N2310	<b>552573</b>

<sup>1</sup> 552572/552574 is used when combining with National Cycle Light Bar P/N 552935



**552571**  
Cutout to Top  
17.50" (44.5cm)  
Overall Width  
18.30" (46.5cm)  
Clear



**552573**  
Cutout to Top  
20.50" (52.0cm)  
Overall Width  
18.30" (46.5cm)  
Clear



**552572**  
Cutout to Top  
17.50" (44.5cm)  
Overall Width  
18.30" (46.5cm)  
Clear



**552574**  
Cutout to Top  
20.50" (52.0cm)  
Overall Width  
18.30" (46.5cm)  
Clear



Dakota 3.0 Windshields are measured from the top of the headlight cutout to the top of the screen and horizontally across the back at the widest point.



No-Hole Ballssocket™ mount with 350° adjustment

Telescoping rake

QuickSet™ pivot handlebar mount for clean, easy installation and quick, no-tool removal

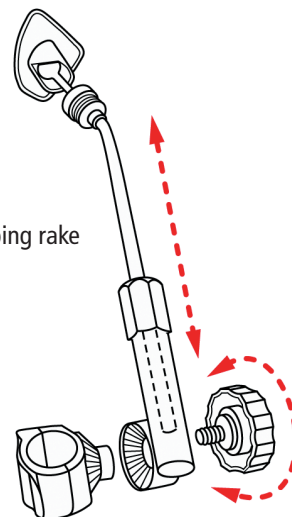

**Plexifairings**

Height: 21.00" (53.5cm)  
Width: 32.00" (81.5cm)

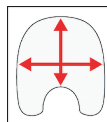

Plexifairings are measured from the top of the headlight cutout to the top of the screen and horizontally across the back at the widest point.

**NATIONAL CYCLE® PLEXIFAIRING 3**

Reduces wind fatigue, great for winter riding.

- D.O.T.-approved high-impact acrylic
- Maximum coverage and wind protection
- Lightweight, aerodynamic, highly functional design
- Includes 1" QuickSet™ mount kit for 10-second no-tool removal
- Made in USA



HARLEY-DAVIDSON	Year	P/N
FXD, FXDC, FXDL, FXDS, FXDX	93-05	<b>552513</b>
XL	57-21	<b>552513<sup>1</sup></b>

<sup>1</sup> Exc. 11-20 XL1200C Custom, XL883C Custom, XL883L Super Low; 10-20 XL1200X Forty-Eight



QuickSet™ Clamps

**NATIONAL CYCLE® REPLACEMENT PARTS**

- Sold in pairs

Type	Mfg/N	P/N
1" Quickset™ Clamps	BAG#77	<b>553077</b>
1-1/4" Quickset™ Clamps	BAG#78	<b>553078</b>

AUDIO, VIDEO & NAVIGATION

INDIAN & VICTORY

WINDSHIELDS

SEATS & SISSY BARS

LUGGAGE

WHEELS

BRAKES

CHASSIS

SUSPENSION

SHEET METAL

EXHAUST

FUEL & AIR SYSTEMS

ENGINE

PRIMARY DRIVE

TRANSMISSION & FINAL DRIVE

GASKETS

HANDLEBARS & CONTROL

CABLES

FOOT CONTROL

INSTRUMENT & LIGHTING

ELECTRICAL

SECURITY & COVERS

GENERAL ACCESSORIES & DISPLAY

CROSS REFERENCE



AUDIO, VIDEO & NAVIGATION



**national cycle**

INDIAN & VICTORY

WINDSHIELDS

SEATS & SISSY BARS

LUGGAGE

WHEELS

BRAKES

CHASSIS

SUSPENSION

SHEET METAL

EXHAUST

FUEL & AIR SYSTEMS

ENGINE

PRIMARY DRIVE

TRANSMISSION & FINAL DRIVE

GASKETS

HANDLEBARS & CONTROL

CABLES

FOOT CONTROL

INSTRUMENT & LIGHTING

ELECTRICAL

SECURITY & COVERS

GENERAL ACCESSORIES & DISPLAY

CROSS REFERENCE



558045

**NATIONAL CYCLE® CHROME LOWER DEFLECTORS**

Extends the protection of your windshield by preventing unwanted turbulence and backdrafts.

- Mounts to the windshield kit for SwitchBlade/ Spartan or Heavy Duty windshields where listed in application charts
- Engineered for proper fit and steering clearance
- Made in USA



Application	Mfg/N	P/N
FX/XLH; SwitchBlade/Spartan	N76605	558045
FLS/FLH; SwitchBlade/Spartan	N76606	558046



558046

**NATIONAL CYCLE® REPLACEMENT TOP FOR BEADED HEAVY DUTY WINDSHIELDS**

- FMR hard-coated Lexan® polycarbonate
- Vintage-style peaked top
- Made in USA



Style	Type	Mfg/N	P/N
Rounded	7-Bolt	20002	553501

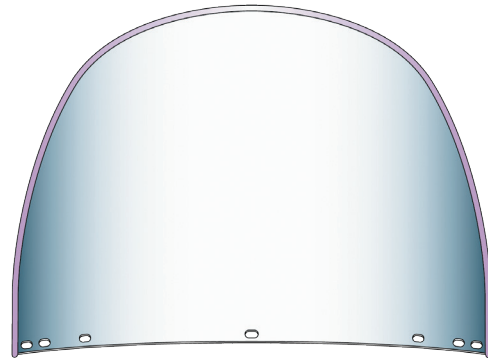

553501



**NATIONAL CYCLE® SHIELD WASH WINDSHIELD CLEANER**

Safe on all motorcycle windshields, face shields and goggles. Strong enough to clean spotlessly; mild enough to use as needed.

Includes:

- 8 oz. bottle of Shield Wash
- 1 oz. spray bottle
- Special microfiber cleaning cloth

Mfg/N	P/N
1401-01	552049



**NATIONAL CYCLE® RAINZIP RAIN REPELLENT**

**Makes rain quickly bead up and blow away.**

Formulated for Quantum™ hard-coated polycarbonate but safe for all windshields.

- Comes in a 3 oz. bottle good for several treatments, each lasting about three months
- Special application cloth and microfiber polishing cloth are included

Mfg/N	P/N
N1410-01	552050

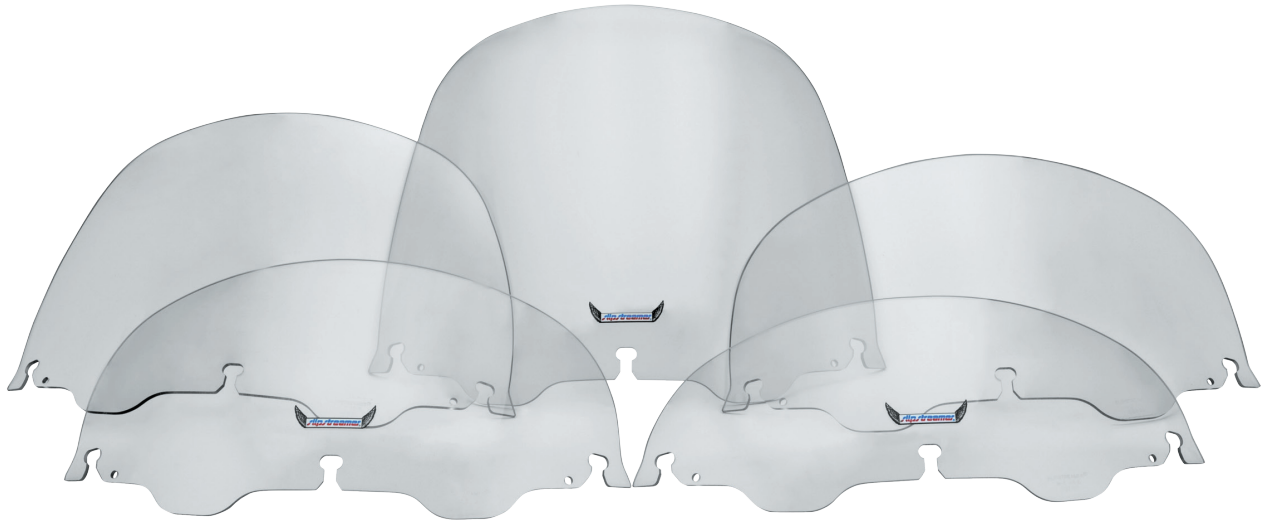

**SLIPSTREAMER® REPLACEMENT WINDSHIELDS**

- Manufactured from 3/16" acrylic
- O.E.M. replacement
- Made in USA



HARLEY-DAVIDSON	Year	Color	6"	8"	10"	12"	13"	14"	16"	18"	19"
FLHT	14-22	Clear			553972		553973		553974		
FLHT	14-22	Smoke	553979	553981	553975		553977		553978		
FLHT	14-22	Dark Smoke	553980	553982	553976						
FLHT	96-13	Clear			559216		559217		559218		
FLHT	96-13	Smoke	559261	559262	559220		559221		559222		
FLHT	96-13	Dark Smoke	559263	559264	559265						
FLTR	15-22	Clear					554035		554036		554037
FLTR	15-22	Smoke					554060		554069		554076
FLTR	15-22	Dark Smoke			554038						
FLTR	04-13	Clear				559240				559242	
FLTR	04-13	Smoke								559245	
FLHTC	86-95	Clear			559200		559201		559202		
FLHTC	86-95	Smoke			559203		559204				
FLT	84-95	Clear							559206		559207
FLT	84-95	Smoke							559209		
FLSB	18-22	Clear		554031	554032	554033		554034			
FLSB	18-22	Smoke		554027	554028	554029		554030			
FLSB	18-22	Dark Smoke		554024	554026	554025					

**SLIPSTREAMER® REPLACEMENT WINDSHIELDS RETAIL PRICING**

P/N	P/N	P/N	P/N	P/N
553972	554024	554035	559203	559222
553973	554025	554036	559204	559240
553974	554026	554037	559206	559242
553975	554027	554038	559207	559245
553976	554028	554060	559209	559261
553977	554029	554069	559216	559262
553978	554030	554076	559217	559263
553979	554031	559200	559218	559264
553980	554032	559201	559220	559265
553981	554033	559202	559221	
553982	554034			

- AUDIO, VIDEO & NAVIGATION
- INDIAN & VICTORY
- WINDSHIELDS**
- SEATS & SISSY BARS
- LUGGAGE
- WHEELS
- BRAKES
- CHASSIS
- SUSPENSION
- SHEET METAL
- EXHAUST
- FUEL & AIR SYSTEMS
- ENGINE
- PRIMARY DRIVE
- TRANSMISSION & FINAL DRIVE
- GASKETS
- HANDLEBARS & CONTROL
- CABLES
- FOOT CONTROL
- INSTRUMENT & LIGHTING
- ELECTRICAL
- SECURITY & COVERS
- GENERAL ACCESSORIES & DISPLAY
- CROSS REFERENCE

AUDIO, VIDEO & NAVIGATION



INDIAN & VICTORY

WINDSHIELDS

SEATS & SISSY BARS

LUGGAGE

WHEELS

BRAKES

CHASSIS

SUSPENSION

SHEET METAL

EXHAUST

FUEL & AIR SYSTEMS

ENGINE

PRIMARY DRIVE

TRANSMISSION & FINAL DRIVE

GASKETS

HANDLEBARS & CONTROL

CABLES

FOOT CONTROL

INSTRUMENT & LIGHTING

ELECTRICAL

SECURITY & COVERS

GENERAL ACCESSORIES & DISPLAY

CROSS REFERENCE



### SLIPSTREAMER® SPITFIRE SPORT SHIELD S-06

Exclusive anodized-aluminum disc hardware is fully adjustable.

- Windshield removable in seconds
- Fits both round and square headlights
- Includes spacer to fit 7/8" bars
- Made in USA
- 15" H x 17-1/4" W



Color	Description	P/N
Clear	1" Clamp also fits 7/8"	559150
Tint	1" Clamp also fits 7/8"	559151
Clear	1" Clamp also fits 7/8", w/ Chrome Hardware	555150
Tint	1" Clamp also fits 7/8", w/ Chrome Hardware	555151
Clear	1-1/4" Clamps	552495
Tint	1-1/4" Clamps	552497

#### Spitfire Sport Shield S-06 Optional Parts

Description	Finish	P/N
1" Bar Clamp Kit	Black	559191
Hardware Kit A-3 7/8" + 1"	Black	559196

### SLIPSTREAMER® S-09 COBRA WINDSHIELD

Small fairing with curved looks and distinctive styling.

- Anodized-aluminum disc hardware
- Fits round and square headlights
- Made in USA
- Includes spacer with 1" clamp, also fits 7/8" bars



P/N  
559152



#### S-09 Cobra Shield Handlebar Clamp Kit

Makes mounting quick and easy. Black anodized aluminum eliminates rust and minimizes corrosion.

- 1" bar clamp
- Black anodized aluminum

P/N  
559191

### SLIPSTREAMER® SS-10 VIPER WINDSHIELD

Unique design for better upper body protection.

- Fully adjustable aluminum disc hardware
- Removable in seconds
- Made in USA
- Dimensions: 17-1/4" H x 22-1/4" W
- Spacer included to fit 7/8" handlebar



Description	Color	P/N
7/8" & 1" Handlebar Mount	Clear	559133
7/8" & 1" Handlebar Mount	Smoke	559134
1-1/4" Handlebar Mount	Clear	559137



#### SS-10 Viper Replacement and Optional Parts

Unique design for better upper body protection.

- Fully adjustable aluminum disc hardware
- Removable in seconds

Description	P/N
1-1/2" Clamp Kit, Black	552488



### SLIPSTREAMER® STEALTH SS-20 WINDSHIELD

- Anodized-aluminum hardware
- 3/16" acrylic windshield
- Standard handlebar clamps, 7/8 to 1/2" adaptors available
- Designed to fit V-Rods
- Made in USA



Color	P/N
Clear	559074
Smoke	559075

#### Stealth SS-20 Replacement and Optional Parts

Description	P/N
1-1/4" Bar Clamp	559212

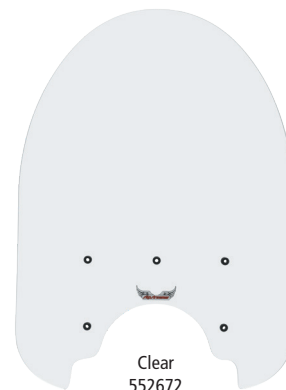

### SLIPSTREAMER® SS-30 CLASSIC

- A beautifully designed shield, that adds a custom look
- Tombstone shape with chrome straps
- Triple chrome-plated hardware
- 3/16" ICI acrylic windshield
- Comes complete with a hardware kit that adapts to different fork diameters and spans universal fitment
- Fits most motorcycle applications
- Quick release hardware
- Made in USA



Application	Size	Color	P/N
39mm Forks	22" H x 23" W	Clear	552672
49mm Forks	22" H x 23" W	Clear	552656



**SLIPSTREAMER® POLICE WINDSHIELD**

- Designed to replicate the original police shield.
- Has quick release hardware for easy on/off
- Anodized-aluminum and stainless hardware
- Standard 1" mounts
- 15" H x 14-1/2" W
- Universal mounting
- Fits XL, Big Twin, V-Rod models
- Made in USA
- Spacer included to fit 7/8"



Description	Color	P/N
1" Clamp also fits 7/8"	Tint	559054
1" Clamp also fits 7/8"	Clear	559055

*Police Windshield Hardware Kit*

Description	P/N
Hardware Kit HD-0	559197



**SLIPSTREAMER® MOTORCYCLE WINDSCREEN CLEANER AND POLISH**

- Cleans and polishes all plastics.
- Removes small surface scratches
- Anti-fog and anti-static

Size	For Case Order	P/N	
7 oz.	12	559000	12.25 ea



559063

**SLIPSTREAMER® TOMBSTONE SHD-3 SPORT SHIELD**

- Nostalgic look.
- Quick release
- Standard 1" hardware
- Made in USA
- 14" H x 10" W
- Includes spacer to fit 7/8" bars



559062



Description	Color	P/N
1" & 7/8" Clamp	Tint	559062
1" & 7/8" Clamp	Clear	559063



559192

*Tombstone SHD-3 Replacement and Optional Parts*

- Nostalgic look
- Quick release
- Standard 1" hardware
- A-3 7/8" + 1"

Description	P/N
7/8" Bar Clamp	559192
Black Hardware Kit	559196

- AUDIO, VIDEO & NAVIGATION
- INDIAN & VICTORY
- WINDSHIELDS**
- SEATS & SISSY BARS
- LUGGAGE
- WHEELS
- BRAKES
- CHASSIS
- SUSPENSION
- SHEET METAL
- EXHAUST
- FUEL & AIR SYSTEMS
- ENGINE
- PRIMARY DRIVE
- TRANSMISSION & FINAL DRIVE
- GASKETS
- HANDLEBARS & CONTROL
- CABLES
- FOOT CONTROL
- INSTRUMENT & LIGHTING
- ELECTRICAL
- SECURITY & COVERS
- GENERAL ACCESSORIES & DISPLAY
- CROSS REFERENCE



## SLIPSTREAMER CROSS REFERENCE

	Application	Year	Spitfire S-06	Cobra S-09	Viper SS-10	Stealth SS-20	Classic/Falcon SS-30/SS-32	Mini Police HD-0	Tombstone HD-3	
WINDSHIELDS	<b>Softail</b>									
	FXCW/C Rocker	08-11	1"	1"	1"	•	V	•	•	
SEATS & SISSY BARS	FXST/C Softails	87-10	1"	1"	1"	•	WG	•	•	
	FXSTS/SE Springer	89-09	1"	1"	1"			•	•	
	FXSTD Deuce	00-07	1"	1"	1"	•	WG	•	•	
LUGGAGE	FXSTB Night Train	99-09	1"	1"	1"	•	WG	•	•	
	FXS Blackline	11-13	1"	1"	1"	•	WG	•	•	
	FLSTF Fat Boy	01-05	1"	1"	1"			•	•	
WHEELS	FLSTF Fat Boy	06-17	1-1/4"	1-1/4"	1-1/4"			1-1/4"	1-1/4"	
	FLSTFB Fat Boy Lo	10-17	1-1/4"	1-1/4"	1-1/4"			1-1/4"	1-1/4"	
	FLS Slim	12-17	1-1/4"	1-1/4"	1-1/4"			1-1/4"	1-1/4"	
BRAKES	FLSTN Softail Deluxe	93-17	1"	1"	1"			•	•	
	FLSTSB Cross Bones	08-11	1"	1"	1"			•	•	
	FLD Switchback	12-15	1"	•	•			•	•	
CHASSIS	<b>Dyna</b>									
	FXD/X/G Super Glide	Pre-05	1"	1"	1"	•	•	•	•	
	FXD Super Glide	06-10	1"	1"	1"	•	V	•	•	
SUSPENSION	FXDC Super Glide Custom	Pre-05	1"	1"	1"	•	•	•	•	
	FXDC Super Glide Custom	06-16	1"	1"	1"	•	V	•	•	
	FXDB Street Bob	06-12	1"	1"	1"	•	V	•	•	
SHEET METAL	FXDB Street Bob	13-16	1-1/4"	1-1/4"	1-1/4"		F	1-1/4"	1-1/4"	
	FXDL Low Rider	99-05	1"	1"	1"	•	•	•	•	
	FXDL Low Rider	06-09	1"	1"	1"	•	V	•	•	
EXHAUST	FXDWG Wide Glide	99-06	1"	1"	1"	•	WG	•	•	
	FXDWG Wide Glide	07-17	1-1/4"	1-1/4"	1-1/4"	1-1/4"	V	1-1/4"	1-1/4"	
	FXDF Fat Bob	08-17	1-1/4"	1-1/4"	1-1/4"	1-1/4"		1-1/4"	1-1/4"	
FUEL & AIR SYSTEMS	FXDFSE CVO Fat Bob	10-11	1-1/4"	1-1/4"	1-1/4"	1-1/4"		1-1/4"	1-1/4"	
	FXDSE Screamin' Eagle	08-09	1-1/4"	1-1/4"	1-1/4"	1-1/4"		1-1/4"	1-1/4"	
	FXSBESE CVO Breakout	12-15	1-1/4"	1-1/4"	1-1/4"	1-1/4"		1-1/4"	1-1/4"	
ENGINE	<b>Sportster</b>									
	XL883/C/L/N	88-22	1"	1"	1"	•	•	•	•	
	XL883 Hugger	All	1"	1"	1"	•	•	•	•	
PRIMARY DRIVE	XL1100	86-87	1"	1"	1"	•	•	•	•	
	XL1200/C/L	88-10	1"	1"	1"	•	•	•	•	
	XL1200C	11-14	1"	1"	1"	•	WG	•	•	
TRANSMISSION & FINAL DRIVE	XL1200N Nightster	07-12	1"	1"	1"	•	•	•	•	
	XL1200R Roadster	01-08	1"	1"	1"	•	•	•	•	
	XL1200S Sport	96-03	1"	1"	1"	•	•	•	•	
GASKETS	XL1200V Seventy-Two	12-16	1"	1"	1"	•	•	•	•	
	XL1200X Forty-Eight	10-22	1"	1"	1"	•	•	•	•	
	XR1200X	11-12	1"	1"	1"			•	•	
HANDLEBARS & CONTROL	<b>Street</b>									
	Street 500	14-20	•	•					•	
	Street 750	14-20	•	•					•	
CABLES	<b>V-Rod</b>									
	VRSC/B/R/AW/DX	02-17	1"	1"	1"	•		•	•	
	VRSCF Muscle	12-17	1-1/2"	1-1/2"					1-1/2"	

- Fits with no modifications
- Order with Oversized Fork Hardware
- 1" Fits with 1" Handlebar Clamps
- WG Order with Wide Glide Fork Hardware
- 1-1/4" Fits with 1-1/4" Handlebar Clamps



### EXCLUSIVE BIKER'S CHOICE® HIDDEN FAIRING SUPPORT

- Allows use of vented fairing lowers or aftermarket engine guards
- Clean up the look of your Road Glide by eliminating the O.E. fairing support mounted to the engine guard
- Made in USA
- Sold in pairs

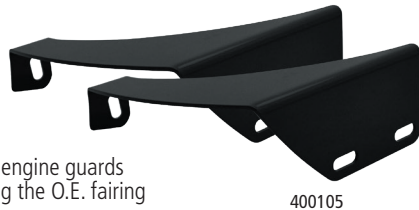

400105



400110

HARLEY-DAVIDSON	Year	Finish	P/N
FLTR	04-21	Black	400110
FLTR	98-03	Black	400105



417867



417866

**HARBAGGER™ REPLACEMENT FAIRING INSERTS KIT**

Repairs stripped out O.E. inserts.

- Installation tool included
- Comes with three inserts
- Easy to use

Description	Qty	P/N
Brass Insert Kit	Kit	<b>417867</b>
Replacement Brass Inserts	9 pk	<b>417866</b>



**PINGEL® V-ROD WINDSHIELD RISERS**

These risers will give you the ability to redirect the airflow over the rider's head instead of directly into the face. Installation is simple and can be done in just a few minutes, with nothing more than a hex key wrench.

- For the 2002 or later V-Rod®, equipped with the Super Sport Windshield
- Polished stainless steel
- Made in USA



**P/N**  
**030595**



**HARBAGGER™ FAIRING BRACKET REPAIR KIT**

Economical way to repair your broken fairing bracket.

- Kit will repair both left and right side fairing brackets
- Easy installation
- All hardware and instructions included
- Fits 89-13 FLH models with Batwing fairings
- Made in USA



HARLEY-DAVIDSON	Year	P/N
FLH	89-13	<b>489995</b>



044330

**COLONY WINDSHIELD TRIM MOUNTING KIT**

Includes all the parts necessary to successfully mount a windshield.

HARLEY-DAVIDSON	Year	Finish	P/N
FL	49-89	Chrome w/Chrome nuts	<b>044330</b>
FL	49-89	Chrome w/CAD nuts	<b>044433</b>
FX	71-89	Chrome w/Chrome nuts	<b>044330</b>
FX	71-89	Chrome w/CAD nuts	<b>044433</b>
XL	57-89	Chrome w/Chrome nuts	<b>044330</b>
XL	57-89	Chrome w/CAD nuts	<b>044433</b>
K	49-56	Chrome w/Chrome nuts	<b>044330</b>
K	49-56	Chrome w/CAD nuts	<b>044433</b>



EXCLUSIVE

**BIKER'S CHOICE® O.E.M. DETACHABLE WINDSHIELD BUSHINGS**

Replacement quality bushings.

- Sold in pack of four

HARLEY-DAVIDSON	Year	P/N
FLHR	94-22	<b>488702</b>
FLSTC	00-17	<b>488702</b>



666309

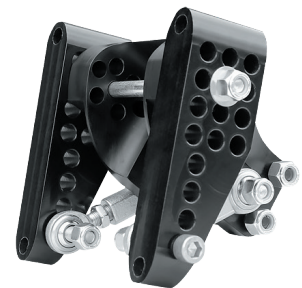

666310

Suspension Neck Kits **ON PAGE 510**

**AMERICAN SUSPENSION FAIRING MOUNT**

- Fairing Mount to fit American Suspension bolt-on or short neck kits

HARLEY-DAVIDSON	Year	P/N
FLTR	15-22	<b>666309</b>
FLTR	98-13	<b>666310</b>

AUDIO, VIDEO & NAVIGATION

INDIAN & VICTORY

WINDSHIELDS

SEATS & SISSY BARS

LUGGAGE

WHEELS

BRAKES

CHASSIS

SUSPENSION

SHEET METAL

EXHAUST

FUEL & AIR SYSTEMS

ENGINE

PRIMARY DRIVE

TRANSMISSION & FINAL DRIVE

GASKETS

HANDLEBARS & CONTROL

CABLES

FOOT CONTROL

INSTRUMENT & LIGHTING

ELECTRICAL

SECURITY & COVERS

GENERAL ACCESSORIES & DISPLAY

CROSS REFERENCE